



COMPACT

COMPACT

DIGITAL AUDIO



DIGITAL Comb Filter



COMBINATION FLAT COLOR TELEVISION AND VIDEO CASSETTE RECORDER / DVD VIDEO PLAYER

MW26G71 MW30G71

OWNER'S MANUAL

Introduction 2

Connections 14

Basic setup 20

TV operation 25

Playback (VCR) 46

Recording (VCR) 51

Other functions (VCR) 55

Basic playback (DVD) 57

Advanced playback (DVD) 60

Function setup (DVD) 69

Others 75

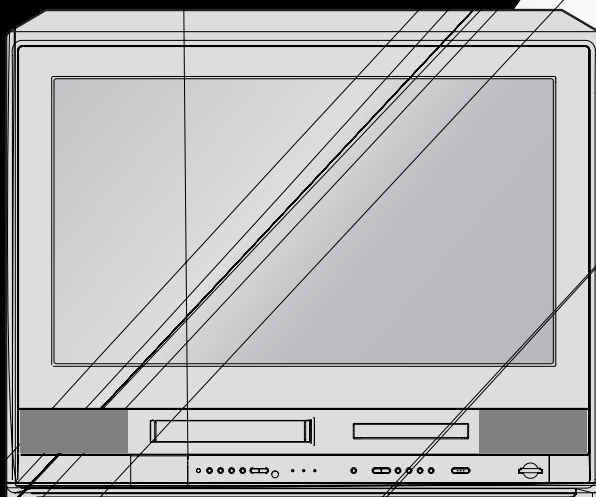

Illustration of MW30G71

©2005 Toshiba Corporation

This device does not tape-record copy protected DVD video discs.

IMPORTANT SAFEGUARDS

Dear Customer,

Thank you for purchasing this Toshiba TV. This manual will help you use the many exciting features of your new TV. **Before operating the TV, please read this manual completely**, and keep it nearby for future reference.

Safety Precautions

WARNING

TO REDUCE THE RISK OF FIRE OR ELECTRIC SHOCK, DO NOT EXPOSE THIS APPLIANCE TO RAIN OR MOISTURE.

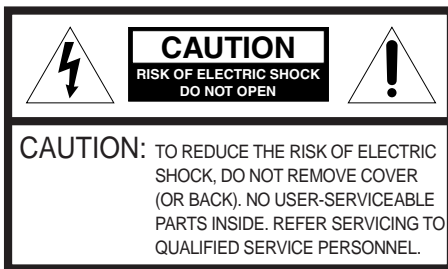

The lightning symbol in the triangle tells you that the voltage inside this product may be strong enough to cause an electric shock. **DO NOT TRY TO SERVICE THIS PRODUCT YOURSELF.**



The exclamation mark in the triangle tells you that important operating and maintenance instructions follow this symbol.

CAUTION: To reduce the risk of electric shock, do not use the polarized plug with an extension cord, receptacle, or other outlet unless the blades can be inserted completely to prevent blade exposure.

NOTE TO CATV INSTALLERS

This is a reminder to call the CATV system installer's attention to Article 820-40 of the NEC, which provides guidelines for proper grounding and, in particular, specifies that the cable ground shall be connected to the grounding system of the building, as close to the point of cable entry as practical. For additional antenna grounding information, see items 25 and 26 on page 4.

NOTICE OF POSSIBLE ADVERSE EFFECTS ON TV PICTURE DISPLAY

If a fixed (non-moving) pattern or image remains on the TV screen for extended periods of time, the image can become permanently ingrained in the cathode ray tube(s) of the TV and cause subtle but permanent ghost images. **This type of damage is NOT COVERED BY YOUR WARRANTY.** See page 4 for details.

It Makes A Difference Where Your TV Stands



Congratulations on your purchase! As you enjoy your new TV, keep these safety tips in mind:

The Issue

- If you are like most consumers, you have a TV in your home. Many homes, in fact, have more than one TV.
- The home theater entertainment experience is a growing trend, and larger TVs are popular purchases; however, they are not always supported on the proper TV stands.
- Sometimes TVs are improperly secured or inappropriately situated on dressers, bookcases, shelves, desks, audio speakers, chests, or carts. As a result, TVs may fall over, causing unnecessary injury.

Toshiba Cares!



- The consumer electronics industry is committed to making home entertainment enjoyable and safe.
- The Consumer Electronics Association formed the Home Entertainment Support Safety Committee, comprised of TV and consumer electronics furniture manufacturers, to advocate children's safety and educate consumers and their families about television safety.

Tune Into Safety

- One size does NOT fit all! Use appropriate furniture large enough to support the weight of your TV (and other electronic components).
- Use appropriate angle braces, straps, and anchors to secure your furniture to the wall (but never screw anything directly into the TV).
- Carefully read and understand the other enclosed instructions for proper use of this product.
- Do not allow children to climb on or play with furniture and TVs.
- Avoid placing any item on top of your TV (such as a VCR, remote control, or toy) that a curious child may reach for.
- Remember that children can become excited while watching a program and can potentially push or pull a TV over.
- Share our safety message about this hidden hazard of the home with your family and friends. Thank you!



2500 Wilson Blvd.
Arlington, VA 22201 U.S.A.
Tel. 703-907-7600 Fax 703-907-7690
www.CE.org

CEA is the Sponsor, Producer and Manager of the International CES®



IMPORTANT SAFEGUARDS

- 24) Always operate this equipment from a 120V AC, 60 Hz power source only.

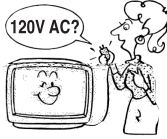

- 25) Always make sure the antenna system is properly grounded to provide adequate protection against voltage surges and built-up static charges (see Section 810 of the National Electric Code).

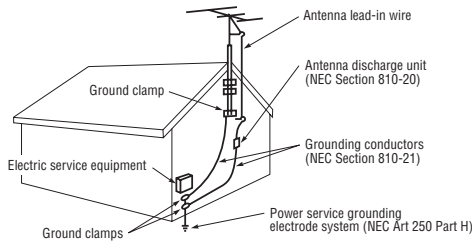

- 26) **! DANGER: RISK OF SERIOUS PERSONAL INJURY OR DEATH!**
- Use extreme care to make sure you are never in a position where your body (or any item you are in contact with, such as a ladder or screwdriver) can accidentally touch overhead power lines. Never locate the antenna near overhead power lines or other electrical circuits.
 - Never attempt to install any of the following during lightning activity:
 - a) an antenna system; or b) cables, wires, or any home theater component connected to an antenna or phone system.

Care

For better performance and safer operation of your TOSHIBA TV, follow these recommendations and precautions:

- 27) Always sit approximately 10–25 feet away from the TV and as directly in front of it as possible. The picture can appear dull if you sit too far to the left or right of the TV, or if sunlight or room lights reflect on the screen. Turn the TV off to check for reflections on the screen, and then remove the source of reflections while viewing the TV.

- 28) Always unplug the TV before cleaning. Never use liquid or aerosol cleaners.

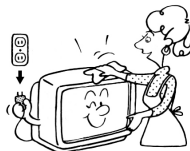

- 29) **! WARNING: RISK OF ELECTRIC SHOCK!** Never spill liquids or push objects of any kind into the TV cabinet slots.

- 30) [This item applies to projection TVs only.] If the air temperature rises suddenly (for example, when the TV is first delivered), condensation may form on the lenses. This can make the picture appear distorted or the color appear faded. If this happens, turn off the TV for 6 to 7 hours to allow the condensation to evaporate.

- 31) For added protection of your TV from lightning and power surges, always unplug the power cord and disconnect the antenna from the TV if you leave the TV unattended or unused for long periods of time.

- 32) During normal use, the TV may make occasional snapping or popping sounds. This is normal, especially when the unit is being turned on or off. If these sounds become frequent or continuous, unplug the power cord and contact a Toshiba Authorized Service Center.

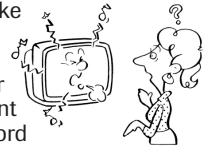

- 33) **Possible Adverse Effects on TV Picture Display** If a fixed (non-moving) pattern or image remains on the TV screen for extended periods of time, the image can become permanently ingrained in the cathode ray tube(s) of the TV and cause subtle but permanent ghost images. **This type of damage is NOT COVERED BY YOUR WARRANTY.**

Never leave the TV on for extended periods of time while it is displaying the following images or formats:

- **Fixed Images**, including but not limited to PIP/POP windows, closed captions, video game patterns, TV station logos, stock tickers, and websites.
- **Special Formats** that do not use the entire screen, including but not limited to widescreen or letterbox format media viewed on a 4:3 aspect ratio display (with gray or black bars at the top and bottom of the screen); or 4:3 aspect ratio format media viewed on a widescreen/16:9 aspect ratio display (with gray or black bars on the left and right sides of the screen).

Service

- 34) **! WARNING: RISK OF ELECTRIC SHOCK!** Never attempt to service the TV yourself. Opening and removing the covers may expose you to dangerous voltage or other hazards. Refer all servicing to a Toshiba Authorized Service Center.

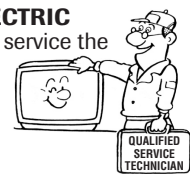

- 35) If you have the TV serviced:

- Ask the service technician to use only replacement parts specified by the manufacturer.
- Upon completion of service, ask the service technician to perform routine safety checks to determine that the TV is in safe operating condition.

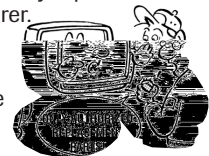

- 36) When the TV reaches the end of its useful life, ask a qualified service technician to properly dispose of the TV. Improper disposal may result in a picture tube implosion and possible personal injury.

SAFETY PRECAUTION/ Power source

WARNING: This equipment has been tested and found to comply with the limits for a Class B digital device, pursuant to Part 15 of the FCC Rules. These limits are designed to provide reasonable protection against harmful interference in a residential installation. This equipment generates, uses and can radiate radio frequency energy and, if not installed and used in accordance with the instructions, may cause harmful interference to radio communications. However, there is no guarantee that interference will not occur in a particular installation. If this equipment does cause harmful interference to radio or television reception, which can be determined by turning the equipment off and on, the user is encouraged to try to correct the interference by one or more of the following measures:

- Reorient or relocate the receiving antenna.
- Increase the distance between the equipment and receiver.
- Connect the equipment into an outlet on a circuit different from that to which the receiver is connected.
- Consult the dealer or an experienced radio/TV technician for help.

CAUTION: Changes or modifications not expressly approved by the party responsible for compliance with the FCC (Federal Communications Commission) Rules could void the user's authority to operate this equipment.

* Notes on copyright section should go on page 8.

CAUTION:
THIS DIGITAL VIDEO PLAYER EMPLOYS A LASER SYSTEM.

TO ENSURE PROPER USE OF THIS PRODUCT, PLEASE READ THIS OWNER'S MANUAL CAREFULLY AND RETAIN FOR FUTURE REFERENCE. SHOULD THE UNIT REQUIRE MAINTENANCE, CONTACT AN AUTHORIZED SERVICE LOCATION.

USE OF CONTROLS, ADJUSTMENTS OR THE PERFORMANCE OF PROCEDURES OTHER THAN THOSE SPECIFIED HEREIN MAY RESULT IN HAZARDOUS RADIATION EXPOSURE.

TO PREVENT DIRECT EXPOSURE TO LASER BEAM, DO NOT TRY TO OPEN THE ENCLOSURE. VISIBLE LASER RADIATION MAY BE PRESENT WHEN THE ENCLOSURE IS OPENED. DO NOT STARE INTO BEAM.

Location of the required Marking

The rating sheet and the safety caution are on the rear of the unit.

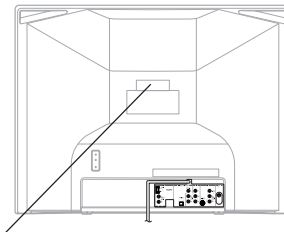

CERTIFICATION: COMPLIES WITH
FDA RADIATION PERFORMANCE
STANDARDS, 21 CFR SUBCHAPTER J.

WARNING: This product contains a laser beam. Do not attempt to stare at the beam through the DVD disc tray or the ventilation openings. Staring directly at the beam may cause permanent damage to your eyesight.

IMPORTANT RECYCLING INFORMATION

This product uses both Cathode Ray Tube (CRT) and other components that contain lead. In your community there might be regulations that require you to dispose these materials properly under environmental considerations. Please contact your local authorities, or the Electronic Industries Alliance (<http://www.eiae.org>) for disposal or recycling information.

Power source

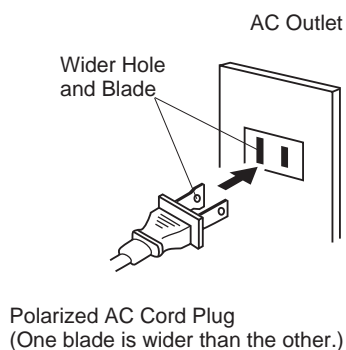

TO USE AC POWER SOURCE

Use the AC polarized line cord provided for operation on AC. Insert the AC cord plug into a standard 120V 60Hz polarized AC outlet.

Notes:

- Never connect the AC line cord plug to other than the specified voltage (120V 60Hz). Use the attached power cord only.
- If the polarized AC cord does not fit into a non-polarized AC outlet, do not attempt to file or cut the blade. It is the user's responsibility to have an electrician replace the obsolete outlet.
- If you cause a static discharge when touching the unit and the unit fails to function, simply unplug the unit from the AC outlet and plug it back in. The unit should return to normal operation.
- If the AC cord plug is plugged in for the first time, wait for approx. 5 seconds before pressing the POWER button.

Precautions

Notes on handling

- When shipping the unit, the original shipping carton and packing materials come in handy. For maximum protection, repack the unit as it was originally packed at the factory.
- Do not use volatile liquids, such as insect spray, near the unit. Do not leave rubber or plastic products in contact with the unit for a long time. They will leave marks on the finish.
- The top and rear panels of the unit may become warm after a long period of use. This is not a malfunction.
- When the unit is not in use, be sure to remove the disc and the video cassette turn off the power.
- If you do not use the unit for a long period, the unit may not function properly in the future. Turn on and use the unit occasionally.

Notes on locating

- Place the unit on a level surface. Do not use it on a shaky or unstable surface such as a wobbly table or inclined stand. The loaded disc or the video cassette may come off the proper position and cause damage to the unit.
- When you place this unit near a TV, radio or VCR, the playback picture may become poor and the sound may be distorted. In this case, place the unit away from the TV, radio or VCR.

Notes on cleaning

- Use a soft, dry cloth for cleaning.
- For stubborn dirt, do not use a chemical such as thinner and benzine, as they will damage the surface of the unit.
- If you use a chemical saturated cloth, follow that product's instructions.

Notes on moisture condensation

Moisture condensation damages the unit. Please read the following carefully.

Moisture condensation occurs, for example, when you pour a cold drink into a glass on a warm day. Drops of water form on the outside of the glass. In the same way, moisture may condense on the head drum or the optical pick-up lens inside this unit, one of the most crucial internal parts of the unit.

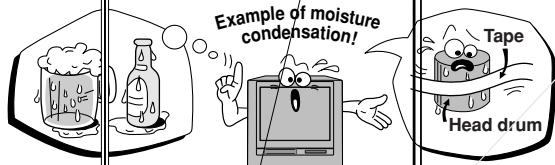

■ **Moisture condensation occurs during the following cases.**

- When you bring the unit directly from a cold place to a warm place.
- When you use the unit in a room where the heater is turned on, or a place where the air conditioner directly hits the unit. In summer, when you use the unit in a room just after you move the unit from a cold air conditioned room.
- When you use the unit in a humid room.

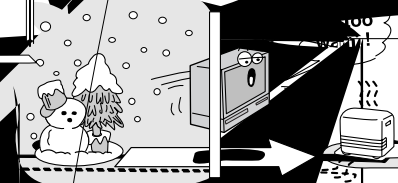

● **Prevention of moisture condensation**

When you use the unit in a room where the heater is on, or where the disc or the video tape, connect the rear panel of the unit to the wall outlet, turn on the power and leave it for two or three hours. After two or three hours, the unit will have warmed up and any moisture will have evaporated. Keep the unit connected to the wall outlet and moisture condensation will not occur.



Contents

Introduction

IMPORTANT SAFEGUARDS	2
SEFETY PRECAUTIONS	5
Power source	5
Precautions	6
Contents	7
Notes and information	8
Identification of controls	11

Connections

Antenna connections	14
Cable TV connections	15
Connecting to optional equipment	16

Basic setup

Starting setup	20
Clock setting	21
Setting the language	24
TV/VCR operation status	24

TV operation

TV operation	25
Closed captions	27
To memorize channels	28
Programming your favorite channels	29
Labeling channels	30
Labeling the video input source	30
Setting the V-Chip	31
Locking the channels	33
Locking the video inputs	34
Setting the GameTimer™	34
Using the front panel lock feature	35
To set the on timer	36
To set the off timer	37
Picture control adjustment	38
Adjusting the picture preference	38
Using the CableClear® feature	39
Selecting the color temperature	39
Selecting the display format	40
Selecting the Scan Velocity Modulation (SVM)	40
Resetting your picture adjustments	41
Selecting the picture size	41
Picture scroll	43
Selecting the cinema mode	43
Using the aspect feature	43
Stereo and Second Audio Program (SAP)	44
Sound control adjustment	44
Selecting the HDMI audio input source	45
Resetting your audio adjustments	45

Playback (VCR)

Loading and unloading a cassette tape	46
Cassette tape playback	47
Special playback	48
Convenient function	49

Recording (VCR)

Recording a TV program	51
One-touch Timer Recording (OTR)	52
Timer recording	53

Other functions (VCR)

Duplicating a video tape	55
Recording a DVD/CD disc	56

Basic playback (DVD)

Playing a disc	57
----------------------	----

Advanced playback (DVD)

Zooming	60
Locating desired scene	60
Repeat playback	61
A-B Repeat playback	61
Program playback	62
Random playback	62
Changing angles	63
Title selection	63
DVD menu	63
Changing soundtrack language	64
Subtitles	64
Disc status	65
To turn off the PBC	65
MP3/WMA/JPEG operation	66

Function setup (DVD)

Customizing the function settings	69
Temporary disabling of rating level by DVD disc	74

Others

Language code list	75
Reception disturbances	76
Troubleshooting	77
Specifications	79
Limited United States Warranty	80

Notes and information

On handling discs

- Do not touch the playback side of the disc.

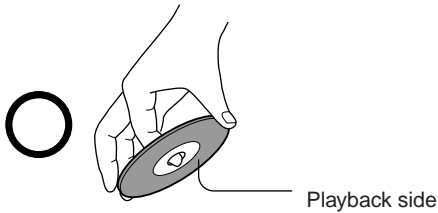

- Do not attach paper or tape to discs.



On cleaning discs

- Fingerprints and dust on the disc cause picture and sound deterioration. Wipe the disc from the center outwards with a soft cloth. Always keep the disc clean.

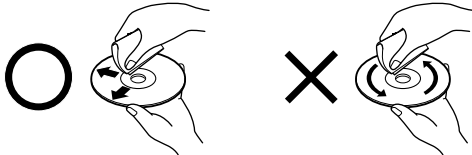

- Do not use any type of solvent such as thinner, benzene, commercially available cleaners or antistatic spray for vinyl LPs. It may damage the disc.

On storing discs

- Do not store discs in a place subject to direct sunlight or near heat sources.
- Do not store discs in places subject to moisture and dust such as a bathroom or near a humidifier.
- Store discs vertically in a case. Stacking or placing objects on discs outside of their case may cause warping.

Structure of disc contents

Normally, DVD video discs are divided into titles, and the titles are sub-divided into chapters. Video CDs and Audio CDs are divided into tracks.

DVD video disc

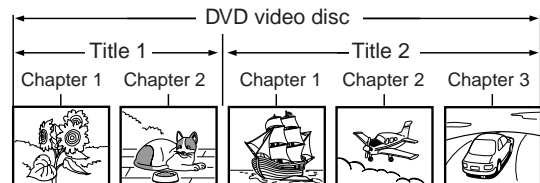

Video CD/Audio CD

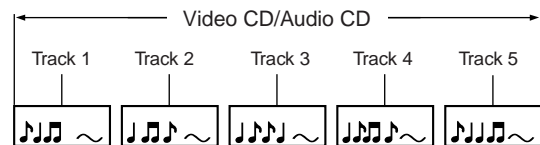

Each title, chapter or track is assigned a number, which is called "title number", "chapter number" or "track number" respectively.

There may be discs that do not have these numbers.

Notes on copyright

The unauthorized recording, use, distribution, or revision of copyrighted materials including, without limitation, television programs, videotapes, and DVDs, is prohibited under the Copyright Laws of the United States and other countries, and may subject you to civil and criminal liability.



This product incorporates copyright protection technology that is protected by method claims of certain U.S. patents and other intellectual property rights owned by Macrovision Corporation and other rights owners. Use of this copyright protection technology must be authorized by Macrovision Corporation, and is intended for home and other limited viewing uses only unless otherwise authorized by Macrovision Corporation. Reverse engineering or disassembly is prohibited.



Notes and information (continued)

Playable Media cards

This unit can play the following cards.

	Card Mark	Contents	Playable card capacity
SD (Secure Digital™) memory card		MP3/ WMA/ JPEG files	32 MB – 1 GB
MMC (MultiMediaCard™)	MMC		8 MB – 1 GB
xD-Picture Card			16 MB – 512 MB
Memory Stick™			16 MB – 128 MB
Memory Stick™ (Pro)	MEMORY STICK		128 MB – 2 GB

- Do not insert any cards other than those listed above as this may cause a malfunction of the unit or cards.
- Some Media cards may not be played back due to its capacity and/or manufacturer, etc.
- This unit cannot play the xD-Picture Card Type M.

Notes on Media cards

- Ensure that you insert the Media card correctly into the media card slot.
- Never remove the Media card or turn off the unit while using the Media card. Doing so may result in loss of data or damage to the Media card or the unit. **SUCH DAMAGE IS NOT COVERED BY YOUR TOSHIBA WARRANTY.**
- It is recommended that you back up your Media card data. Toshiba is not liable for any damage caused by the use of any Media card with this unit. Toshiba will not compensate for any lost data or recording(s) caused by the use of such cards.
- Media card is a precision electrical instrument. Do not bend, drop or apply strong force to it.
- Do not use or store the Media card in an environment of high static electricity or electrical interference.
- Avoid using or storing in areas of high temperature and humidity.
- Prevent contact of the metallic area on the Media card with dust, dirt, or other foreign particles. Do not touch the metallic area of the Media card with your hands or otherwise handle it with anything other than a soft, dry, lint-free, antistatic cloth.
- Use index labels made exclusively for your specific brand of Media card. Do not use commercially sold labels, which can cause a malfunction when the card is inserted or ejected.
- When ejecting the Media card after extended use it may feel warm to the touch. This is normal. The Media card is not malfunctioning.
- For instructions on using your Media card, refer to the owner's manual for your Media card.

SD is a trademark of SD Card Association.

MMC and MultiMediaCard are trademarks of Infineon Technologies AG and licensed to MMCA (MultiMediaCard Association).

xD-Picture Card™ is a trademark of Fuji Photo Film Co., Ltd.

Memory Stick is a trademark of Sony Corporation.

Identification of controls

See the page in [redacted] for details.
This owner's manual uses the illustrations of MW30G71.

Front panel

Illustration of MW30G71

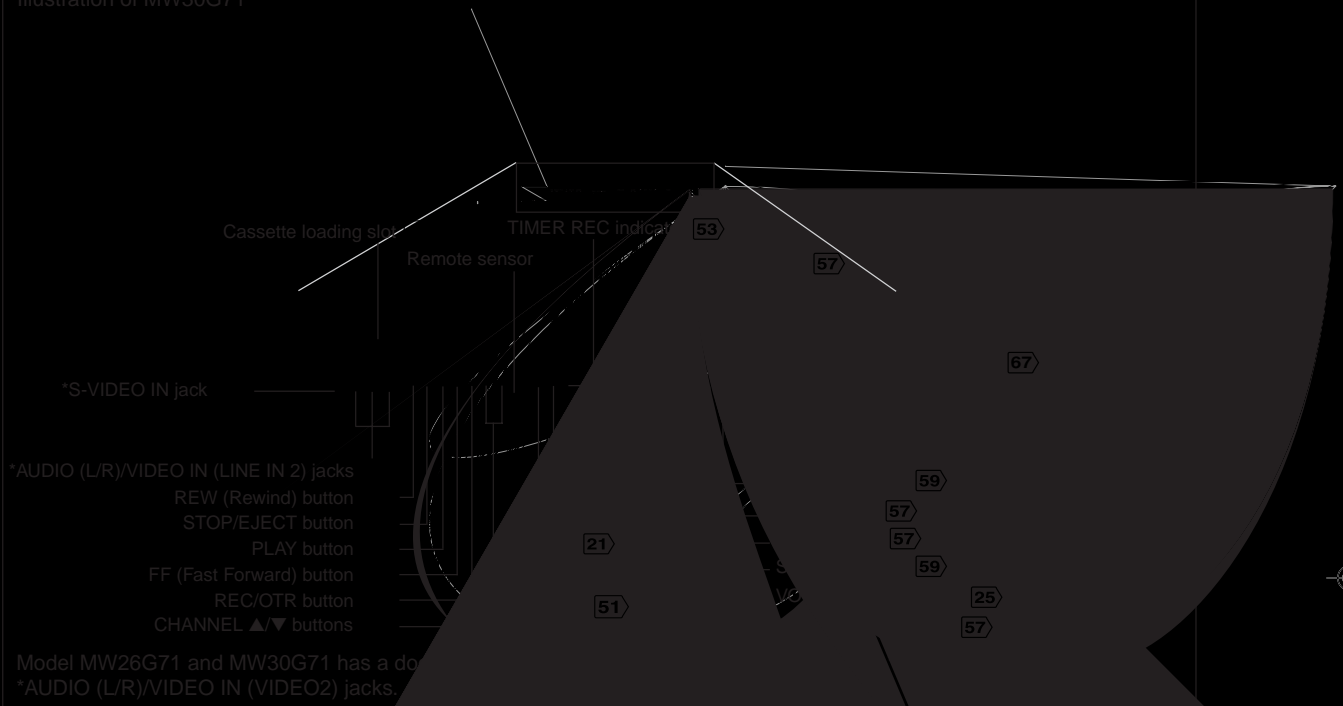

Rear panel

When connecting the optical digital cable, remove the cap and fit the connector to the jack firmly. When not using the jack, keep the cap in place to protect it from dust intrusion.

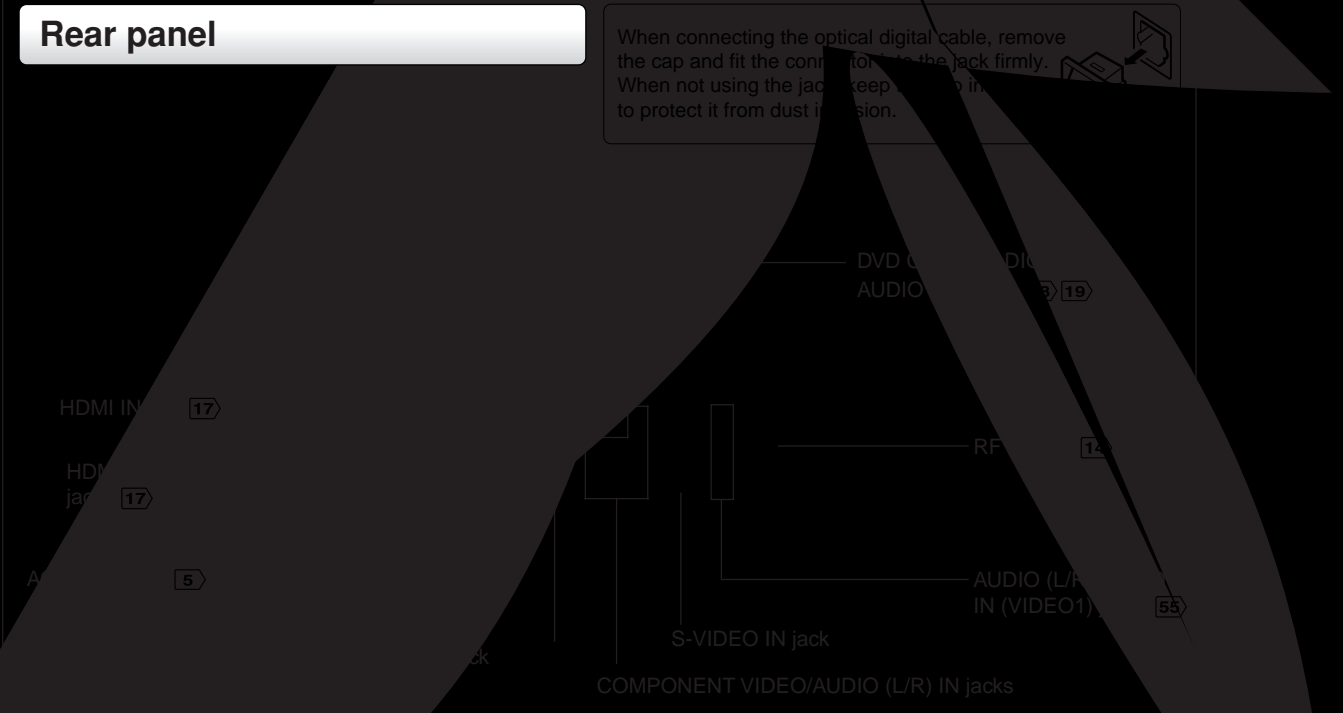

Identification of controls (continued)

Remote control

The instructions in this manual describe the function on the remote control. See the page in for details.

***DVD MENU button**
Use the DVD MENU button to display the menu included on many DVD video discs. To operate a menu, follow the instructions in "DVD menu." 63

Inserting batteries

1 Open the battery compartment cover in the direction of the arrow.

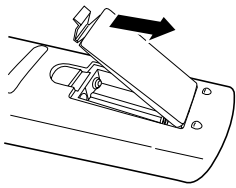

2 Install two "AAA" batteries (supplied), paying attention to the polarity diagram in the battery compartment.

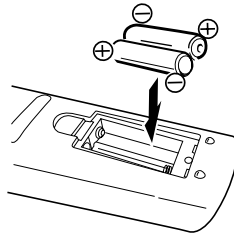

3 Replace the compartment cover.

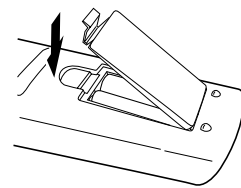

Caution:

Never throw batteries into a fire.

Notes:

- Be sure to use AAA size batteries.
- Dispose of batteries in a designated disposal area.
- Batteries should always be disposed of with the environment in mind. Always dispose of batteries in accordance with applicable laws and regulations.
- If the remote control does not operate correctly, or if the operating range becomes reduced, replace batteries with new ones.
- When necessary to replace batteries in the remote control, always replace both batteries with new ones. Never mix battery types or use new and used batteries in combination.
- Always remove batteries from remote control if they are dead or if the remote control is not to be used for an extended period of time. This will prevent battery acid from leaking into the battery compartment.

Remote control basics

- Press **POWER** to turn the unit on or off.
- Select your desired operating mode (TV/VCR or DVD) using **TV/VCR** or **DVD**.
- Tap **CH** \wedge or \vee to move through the channels one channel at a time.
- The **Direction** buttons (\blacktriangle / \blacktriangledown / \blacktriangleleft / \blacktriangleright) are also used to navigate on-screen menu system.
- You can directly access specific channels using **Direct channel selection** buttons.

Operation:

- Aim the remote control at the remote sensor and press control buttons to operate.
- Operate the remote control within 30° angle on either side of the remote sensor, up to a distance of approx. 5 meters.

Illustration of MW30G71

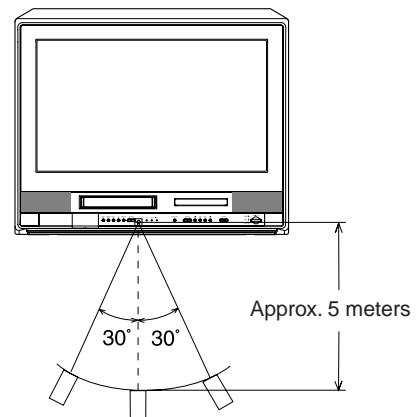



Cable TV connections

This unit has an extended tuning range and can tune most cable channels without using a cable TV converter box. Some cable companies offer "premium pay channels" in which the signal is scrambled. Descrambling these signals for normal viewing requires the use of a descrambler device which is generally provided by the cable TV company.

For subscribers to basic cable TV service

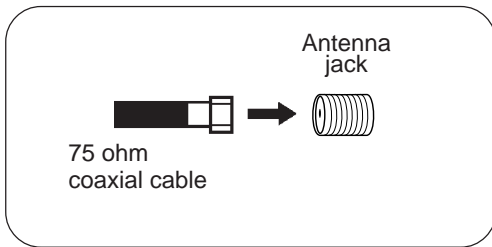

For basic cable TV service not requiring a converter/descrambler box, connect the cable TV 75 ohm coaxial cable directly to the Antenna jack on the back of the unit.

For subscribers to scrambled cable TV service

If you subscribe to a cable TV service which requires the use of a converter/descrambler box, connect the incoming 75 ohm coaxial cable to the converter/descrambler box. Using another 75 ohm coaxial cable, connect the output jack of the converter/descrambler box to the antenna jack on the unit. Follow the connections shown below. Set the unit to the output channel of the converter/descrambler box (usually channel 3 or 4) and use the converter/descrambler box to select channels.

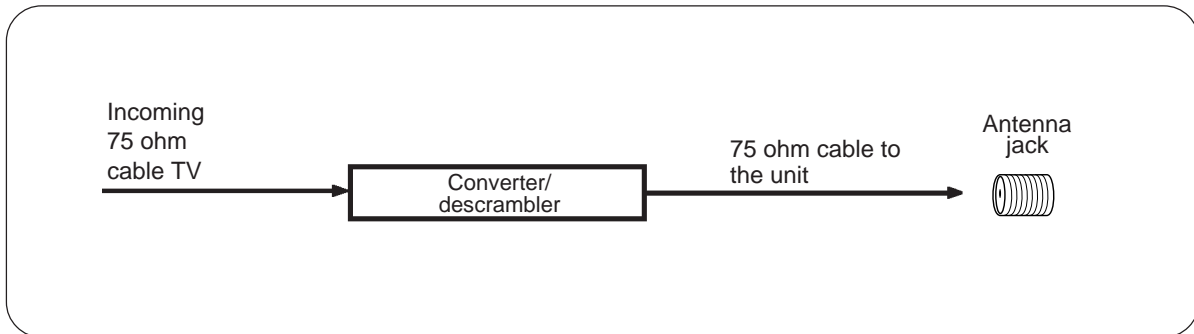

For subscribers to unscrambled basic cable TV service with scrambled premium channels

If you subscribe to a cable TV service in which basic channels are unscrambled and premium channels require the use of a converter/descrambler box, you may wish to use a signal splitter and an A/B switch box (available from the cable TV company or an electronics supply store). Follow the connections shown below. With the switch in the "B" position, you can directly tune any unscrambled channels on your unit. With the switch in the "A" position, tune your unit to the output of the converter/descrambler box (usually channel 3 or 4) and use the converter/descrambler box to tune scrambled channels.

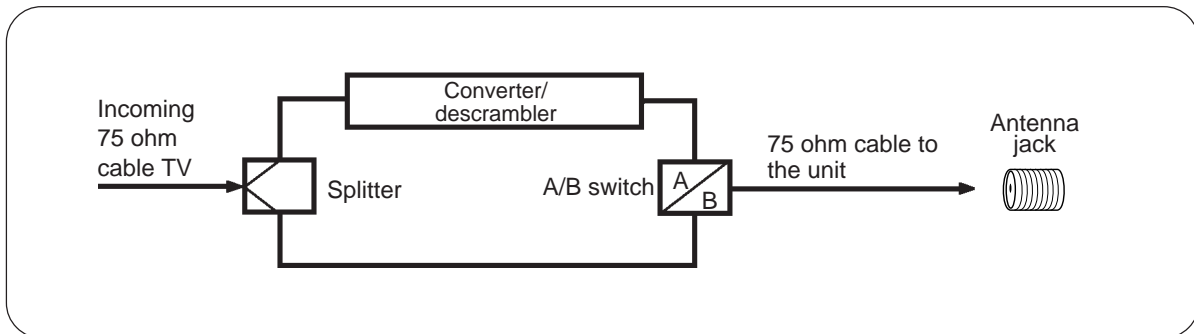

Connecting to optional equipment

Before connecting the unit to other equipment, be sure to turn off the power and unplug all of the equipment from the wall outlet before making any connections. You can enjoy the TV game, camcorder or high quality dynamic sounds of DVD video discs or audio CDs by connecting the unit to optional audio equipment.

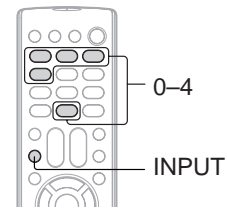

Selecting the video input source

Press **INPUT** to view a signal from another device connected to your TV, such as a VCR or DVD player. You can select ANT, VIDEO1, VIDEO2 (on the front panel), ColorStream HD or HDMI depending on which input jacks you used to connect your devices.

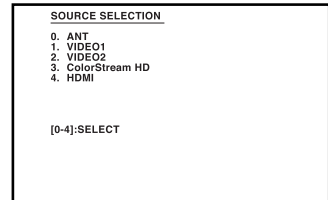

Pressing **INPUT** on the remote control displays the current signal source. To change the input source, press **INPUT** again or press **0-4**.

Connecting a camcorder or a TV game

To playback from the camcorder or playing a TV game, connect the camcorder to the unit as shown. And select "VIDEO2" input source.

➔ Signal flow

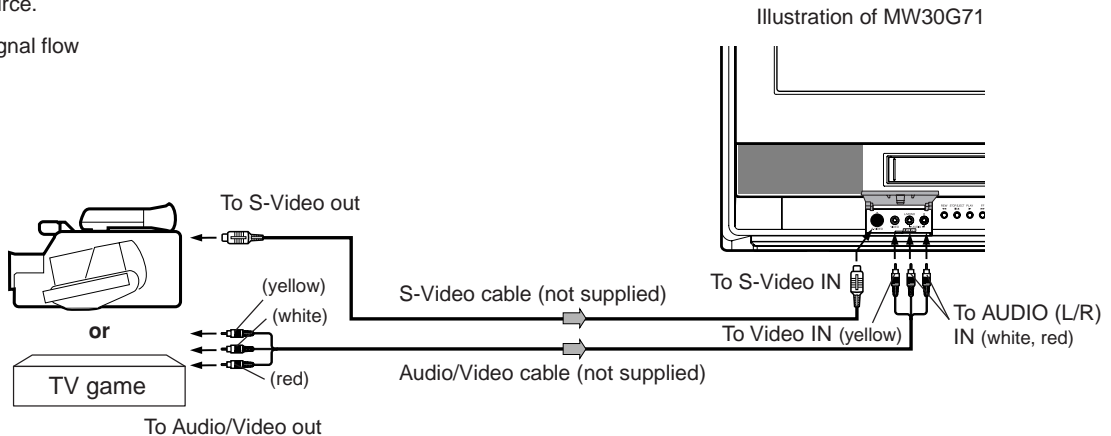

Notes:

- If your camcorder has S-video, you can use an S-video cable (plus the standard audio cables) instead of a standard video cable for better picture quality. Do not connect both a standard video cable and an S-video cable at the same time, or the picture performance will be unacceptable.
- You can also use the S-VIDEO IN or AUDIO(L/R)/VIDEO IN jacks on the rear of the unit.

Connecting a DTV receiver / set-top box with ColorStream® (component video)

This connection allows you to watch DTV (digital TV) and TV programs, and record DTV and TV programs. Your TV has ColorStream® (component video) inputs. Connecting your TV to a DTV receiver with component video can greatly enhance picture quality and realism.

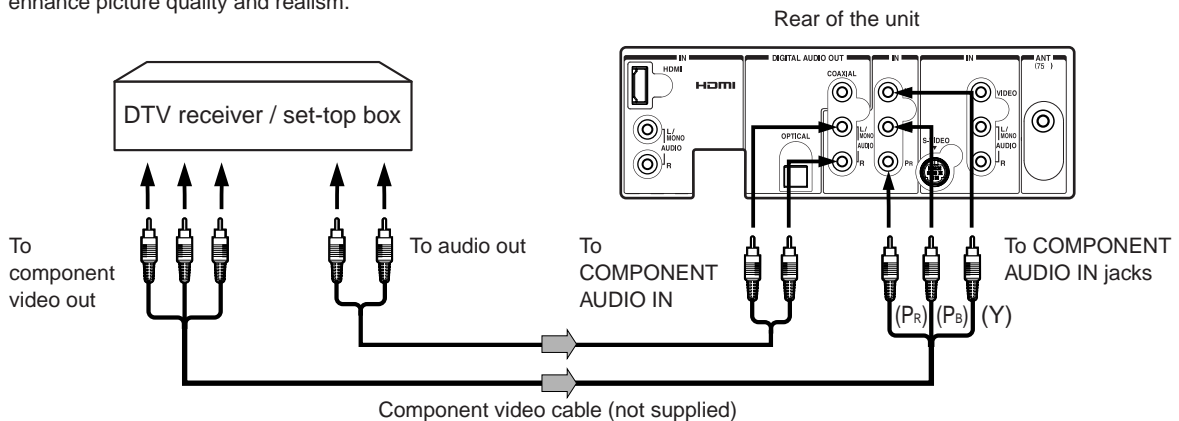

Connecting an HDMI™ device to the HDMI input

The HDMI^[1] input on your unit receives digital audio and uncompressed digital video from an HDMI device or uncompressed digital video from a DVI^[2] device.

This input is designed to accept HDCP^[3] program material in digital form from EIA/CEA-861/861B-compliant^[4] consumer electronic devices (such as a set-top box or DVD player with HDMI or DVI output.)

The HDMI input is designed for best performance with high definition video signals. It will accept and display 480i, 480p, 720p and 1080i signals.

[1] HDMI = High-Definition Multimedia Interface.

[2] DVI = Digital Video Interface.

[3] HDCP = High-bandwidth Digital Content Protection.

[4] EIA/CEA-861/861B compliance covers the transmission of uncompressed digital video with high-bandwidth digital content protection, which is being standardized for reception of high-definition video signals. **Because this is an evolving technology, it is possible that some devices may not operate properly with the unit.**

HDMI cable transfers both video and audio. Separate analog audio cables are not required (see illustration below.)

For proper operation, it is recommended that you use as short an HDMI cable as possible. You should not encounter difficulty if you use an HDMI cable that is shorter than 16.4 ft (5m.)

You must set the HDMI audio input setting to “HDMI” in the AUDIO menu [45].

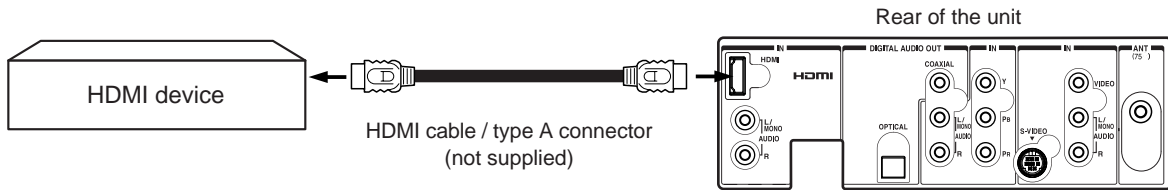

Connecting a DVI device to the HDMI input

An HDMI-to-DVI adapter cable transfers only video.

Separate analog audio cables are required (see illustration below.)

For proper operation, the length of an HDMI-to-DVI adapter cable should not exceed 9.8 ft (3m.) The recommended length is 6.6 ft (2m.)

You must set the HDMI audio input setting to “DVI” in the AUDIO menu [45].

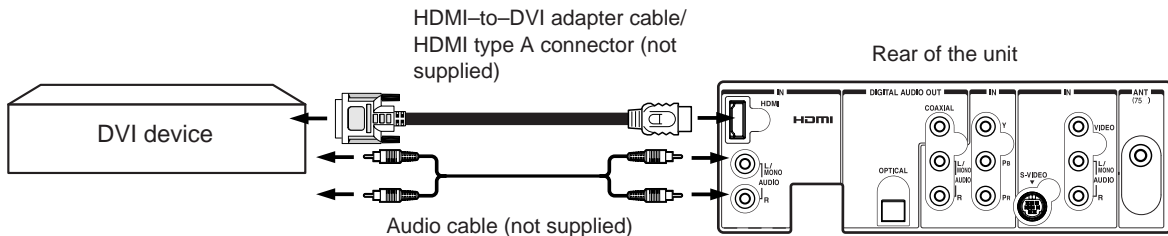

Notes:

- **NEVER CONNECT THIS TV TO A PERSONAL COMPUTER (PC.) This TV is not intended for use with a PC.**
- To ensure that the HDMI or DVI device is reset properly, it is recommended that you follow these procedures:
- When turning on your electronic components, **turn on the TV first**, and then the HDMI or DVI device.
- When turning off your electronic components, **turn off the HDMI or DVI device first**, and then the unit.
- If you connect an HDMI device and analog audio cables and play media with digital audio output, to hear digital audio you must set the HDMI audio input setting to “HDMI” [45].

HDMI, the HDMI logo, and High-Definition Multimedia Interface are trademarks or registered trademarks of HDMI Licensing, LLC.



l eq

sound



Connecting to an amplifier equipped with a Dolby Digital decoder

Dolby Digital... Dolby Digital... showing the latest movi...
duce this real... can... and live concert DVD...
realistic sound b... 6 c... equipped with a Dolby Dig...
processor. If you... Pro... er, you will obtain the full bene...
movies that provide... y D... tracks, as well as from titles with...

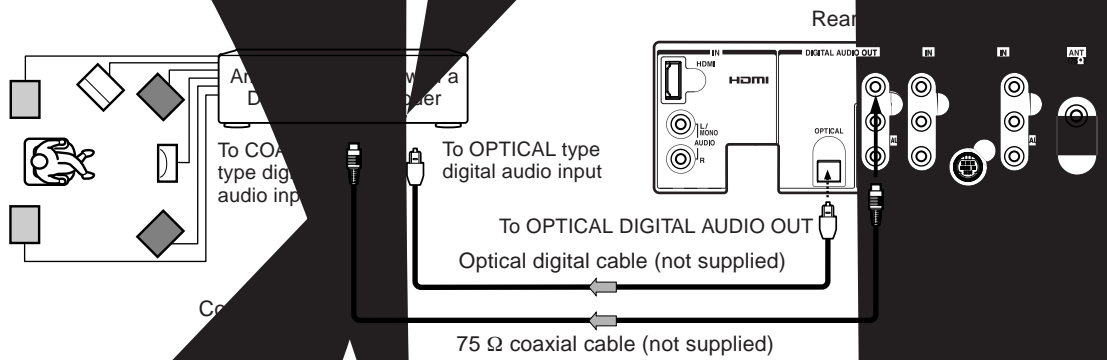

Connecting to an amplifier equipped with a DTS decoder

DTS (DTS)
ound technology used in theaters and now available for home use...
oder or processor, you can obtain the full benefit of 5.1 channel D...
CDs.

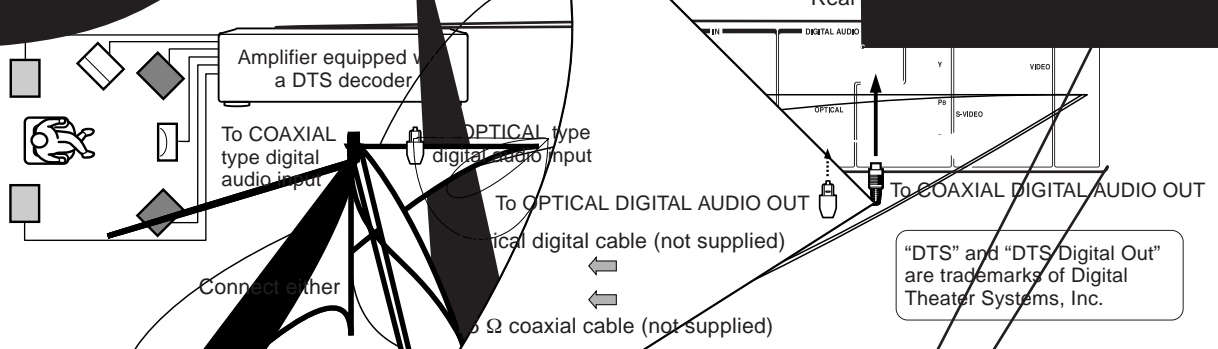



Connecting to an amplifier equipped with a MPEG audio decoder

MPEG2 sound

You can enjoy motion picture and live concert sound with an MPEG2 audio decoder or

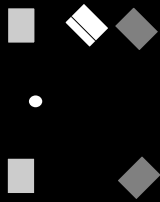

Amplifier equipped with MPEG2 audio decoder

To COAXIAL type digital audio input

Connect either

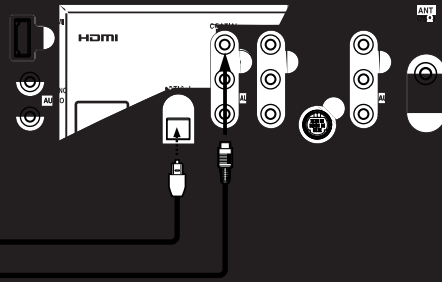

Connecting to an amplifier equipped with a digital audio input

2 channel digital stereo

You can enjoy the dynamic sound of 2 channel digital

connecting an

Rear of the un

AUDIO OUT
(supplied)

(supplied)

DIGITAL AUDIO OUT
(reserved for Laser
AUDIO OUT jack
AUDIO OUT jack

er and un

the rec
soun
rd



Starting setup

The STARTING SETUP function makes installing your unit easily. It leads you the Language selection, TV/CABLE selection and auto channel memory automatically.

IMPORTANT: Make sure that the antenna or cable TV system connection is made!

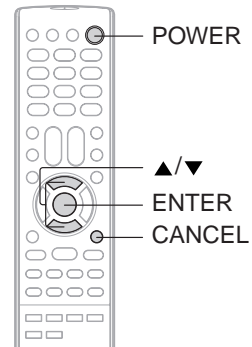

Starting setup

- 1** Press **POWER**.
The starting setup function begins and the Language setup menu appears on the screen. Press **▲** or **▼** to select your desired language, then press **ENTER**.



- 2** Press **▲** or **▼** to select "TV" or "CABLE", then press **ENTER**.

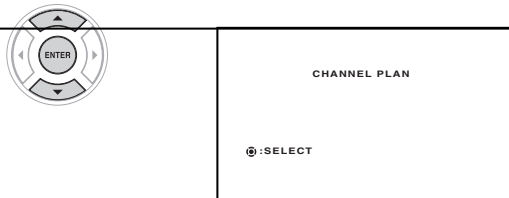

- 3** Press **▲** or **▼** to select "START", then press **ENTER**.
If you select "CANCEL" and press **ENTER**, the STARTING SETUP stops and changes to the TV screen.



- 4** Now the "AUTO CH MEMORY" and "AUTO CLOCK" starts.

After the starting setup is completed, the TV channel appears on the screen.



Notes:

- The starting setup function will work only when you press **POWER** for the first time.
- In "AUTO CLOCK" setting, it may take more than 10 minutes to read the EDS signal for one channel, which has only "Time of day" or "Local time zone".

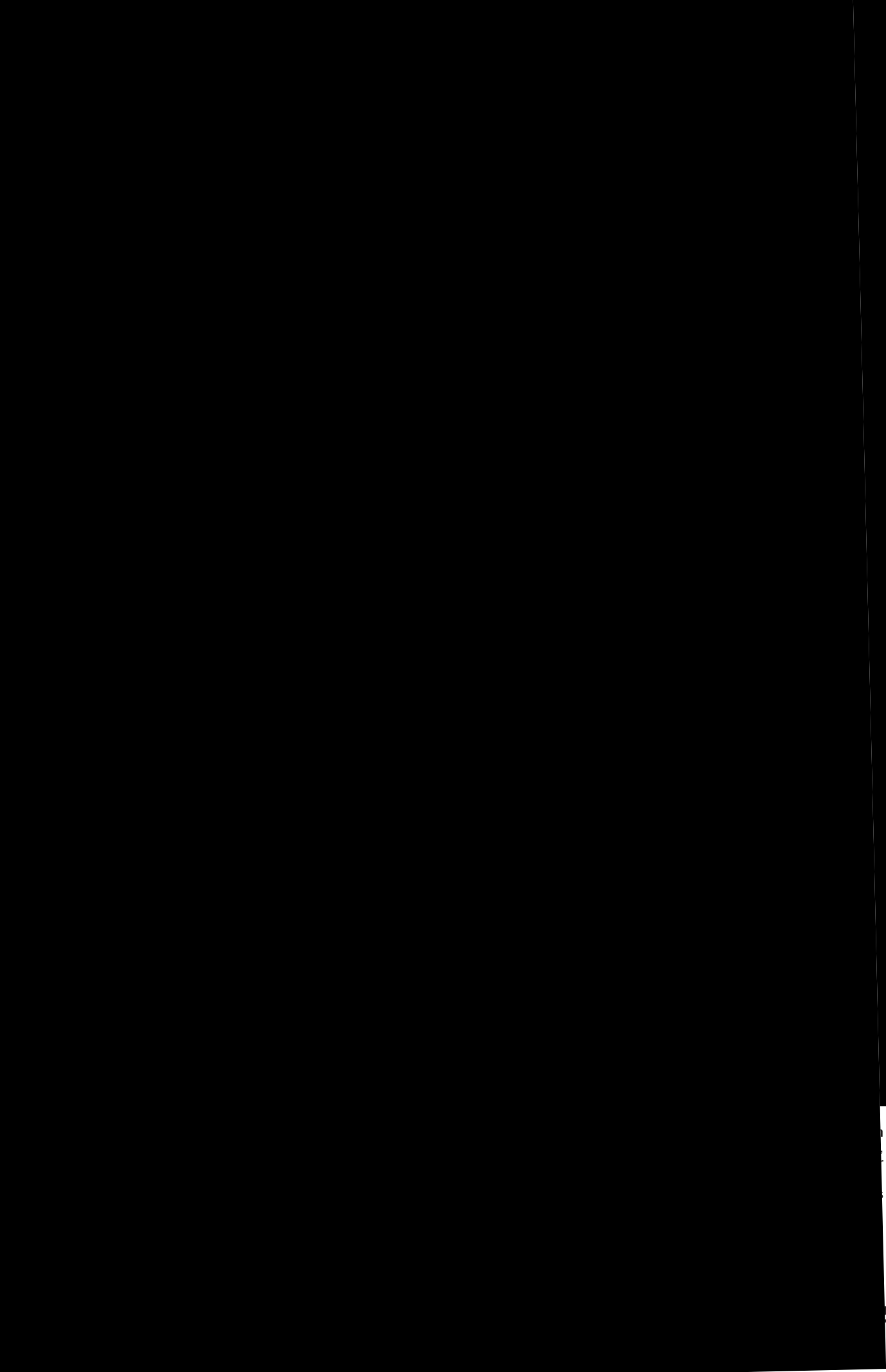

Clock setting (continued)

To set standard time

In the rare event that you live within broadcast range of two stations in two different time zones, the unit may recognize the wrong station for the auto clock set.

To correct the situation:

1 Press MENU in the TV/VCR mode, then press ◀ or ▶ to select TV SETUP  menu.

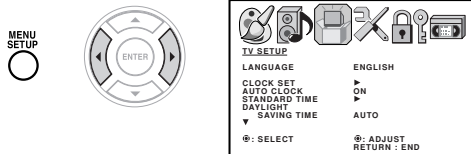

2 Press ▲ or ▼ to select "STANDARD TIME", then press ▶.



3 Press ▲ or ▼ to select your time zone, then press ENTER.

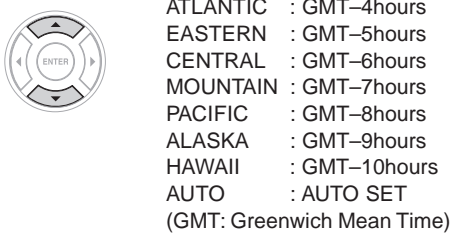

4 Press RETURN to make the menu screen disappear.



Note:
To be able to select the standard time, the clock must first be set by "AUTO CLOCK" once.

To set daylight saving time

You can set the daylight saving time automatically or manually.

1 Press MENU in the TV/VCR mode, then press ◀ or ▶ to select TV SETUP  menu.

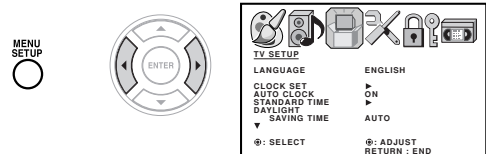

2 Press ▲ or ▼ to select "DAYLIGHT SAVING TIME".

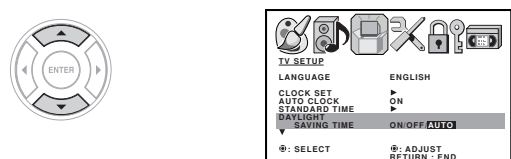

3 Press ◀ or ▶ to select one of the options.



ON: for manual setting (forward one hour)
OFF: for manual setting (back one hour)
AUTO: for automatic setting (read EDS in the signal)

When you want to set the daylight saving time manually, on the first Sunday in April you set to "ON", and on the last Sunday in October you set to "OFF".

4 Press RETURN to make the menu screen disappear.



Notes:

- When shipped from factory, the DAYLIGHT SAVING TIME is set to "AUTO" position.
- When the clock is not set, daylight saving time setting is not available.
- When there is no daylight saving time in your area, always select "OFF" position in step 3.

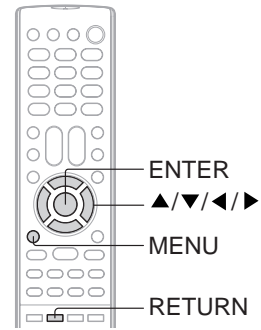

Manual clock setting

You must set the date and time manually for timer recordings, ON/OFF timer and daylight saving time if the auto clock process did not set them correctly.

EXAMPLE: Setting the clock to "8:30 AM", 29th. (SAT) October, 2005.

1 Press **MENU** in the TV/VCR mode, then press **◀** or **▶** to select **TV SETUP** menu.

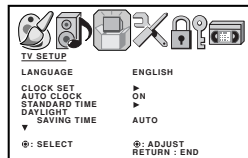

2 Press **▲** or **▼** to select "CLOCK SET", then press **▶**. The **CLOCK SET** menu will appear.

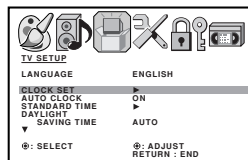

3 Press **◀** or **▶** to set the month, then press **▼**.

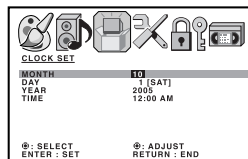

4 Set the day, year and time as in step 3, then press **ENTER**.

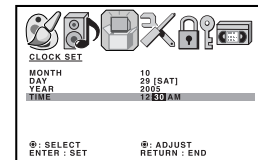

5 After setting the clock, date and time starts functioning automatically.

■ **To make corrections any time during the process**
Press **▲** or **▼** repeatedly until the item you want to change blinks, then set the item again.

Notes:

- After a power failure or disconnection of the power, the timer settings will be lost. In this case, reset the present time.
- When you set the minute, you can change in 10-minutes step by holding down **◀** or **▶**.

Setting the language/ TV/VCR operation status

Setting the language

This unit can display the on screen language in English, Spanish or French.

- 1 Press **MENU** in the TV/VCR mode, then press **◀** or **▶** to select **TV SETUP**  menu.

- 3 Press **◀** or **▶** to select the desired language: English (**ENGLISH**), French (**FRANÇAIS**) or Spanish (**ESPAÑOL**).

- 4 Press **RETURN** to make the menu screen disappear.

TV/VCR operation status

Press **DISPLAY** to display the information on the screen. To cancel the display, press **DISPLAY** again.

While watching TV

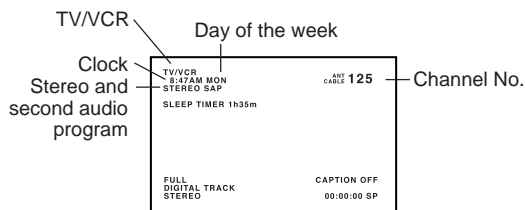

While operating a tape

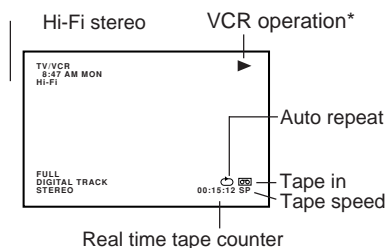

VCR operation*

- | | |
|----------------|-------------|
| Recording : | Rewind : ◀◀ |
| Rec/Pause : | Stop : ◀ |
| Play : | Eject : |
| Fast-forward : | |

TV operation

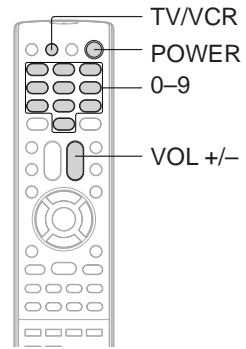

TV operation

1 To turn on the unit, press POWER.
 The Power indicator will light.
 • Every time you turn on the TV, the unit starts from TV/VCR mode. When you use TV/VCR after DVD operation, press **TV/VCR**.

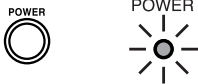

2 Adjust the volume level by pressing VOL + or -.
 The volume level will be indicated on the screen by green bars. As the volume level increases, so do the number of bars. If the volume decreases, the number of green bars also decreases.

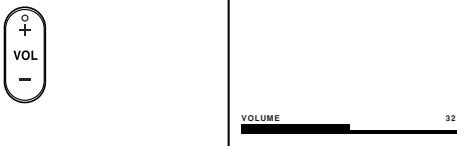

3 Set the TV/CABLE selection to the appropriate position **28.**

TV - VHF/UHF channels
CABLE - Cable TV channels

4 Press Direct channel selection buttons (0-9) to select the channel.

TV mode direct channel selection

When the TV/CABLE selection is in the TV position, all channels can be instantly selected by using two buttons. (for example, to select channel 2, press "0", then "2". If you press only "2", channel selection will be delayed for a few seconds.) For channels 10 and above, press the 2 digits in order.

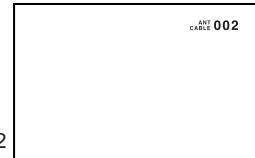

CABLE mode direct channel selection

When the TV/CABLE selection is in the CABLE position, channels can be selected as follows:
TO SELECT CABLE TV CHANNELS:

- 1-9: Press "0" twice, then 1-9 as needed. Example, to select channel 2, press "002".
- 10-12: Press "0", then the remaining 2 digits. Example, to select channel 12, press "012".
- 13-99: Press the 2 digits in order. Example, to select channel 36, press "36".
- 100-125: Press the 3 digits in order. Example, to select channel 120, press "120".

NOTE FOR CHANNELS:

If only one or two buttons are pressed, the corresponding channel will be selected in 2 seconds.

TV	Cable TV
VHF 2-13	VHF 2-13
UHF 14-69	STD/HRC/IRC 14-36 (A) (W) 37-59 (AA) (WW) 60-85 (AAA) (ZZZ) 86-94 (86) (94) 95-99 (A-5) (A-1) 100-125 (100) (125) 01 (5A)

Notes:

- If a channel with no broadcast is selected, the sound will automatically be muted.
- If a station being viewed stops broadcasting, the TV will automatically shut itself off after 15 minutes.

TV operation



TV operation (continued)

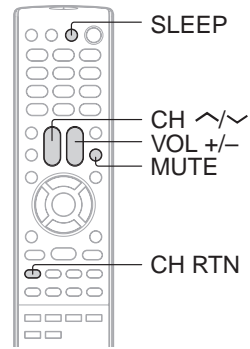

TV operation

■ CHANNEL UP/DOWN

Press and release **CH** \wedge or \vee . The channel automatically stops at the next channel set into memory. For proper operation, before selecting channels, they should be set into the memory. See "To memorize channels" **28**.

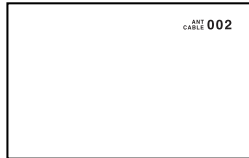
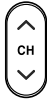

■ CHANNEL RETURN

This button allows you to go back to the last channel selected by pressing **CH RTN**. Press **CH RTN** again to return to the last channel you were watching.

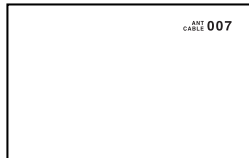

■ MUTE

Press **MUTE** to switch off the sound. The unit's sound will be silenced and "MUTE" will briefly appear on the screen. The sound can be switched back on by pressing this button again or one of **VOL +/-**.

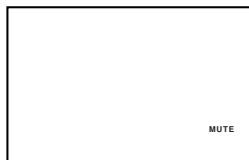

■ SLEEP

To set the unit to turn off after a preset amount of time, press **SLEEP** on the remote control. The clock will count down 10 minutes for each press of **SLEEP** (2h00m, 1h50m, ... 0h10m, 0h00m,). After the sleep time is programmed, the display will appear briefly every 10 minutes to remind you that the sleep timer is operating. To confirm the sleep timer setting, press **SLEEP** and the remaining time will be displayed for a few seconds. To cancel the sleep timer, press **SLEEP** repeatedly until the display turns to "0h00m".





Closed captions

WHAT IS CLOSED CAPTIONING?

This television has the capability to decode and display closed captioned television programs. Closed captioning will display text on the screen for hearing impaired viewers or it will translate and display text in another language.

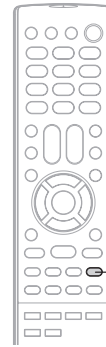

CLOSED CAPTION

Closed captions

Captions: This closed caption mode will display text on the screen in English or another language (depending on the setting of the closed captions CH 1/2).

Generally, closed captions in English are transmitted on captions channel 1 and closed captions in other languages are transmitted on captions channel 2.

Text: The text closed caption mode will usually fill the screen with a programming schedule or other information. After selecting a closed caption mode, it will stay in effect until it is changed, even if the channel is changed.

If the captions signal is lost due to a commercial or a break in the signal, the captions will reappear when the signal is received again. If the channels are changed, the captions will be delayed approximately 10 seconds. The captions will appear in places on the screen where they will least interfere with the picture, usually on the bottom of the screen. News programs will usually show three-line closed captions which scroll onto the screen. Most other shows provide two or three lined captions placed near the character who is speaking so the viewer can follow the dialogue. Words in italics or underlined describe titles, words in foreign languages or words requiring emphasis. Words that are sung usually appear enclosed by musical notes.

For television programs broadcasting with closed captions, look in your TV guide for the closed captions symbol (CC).

TO VIEW CLOSED CAPTIONS

Press **CLOSED CAPTION** to switch between normal TV and the two closed caption modes (captions and full screen text). Closed captioning will display text on the screen for hearing impaired viewers.

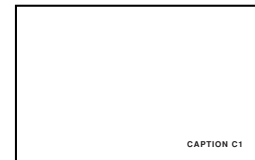

TV operation

Notes:

- When selecting closed captions, the captioning will be delayed approximately 10 seconds.
- If no caption signal is received, no captions will appear, but the television will remain in the caption mode.
- Misspellings or unusual characters may occasionally appear during closed captioning. This is normal with closed captioning, especially with live programs. This is because during live programs, captions are also entered live. These transmissions do not allow time for editing.
- When captions are being displayed, on-screen displays, such as volume and mute may not be seen or may interfere with closed captions.
- Some cable TV systems and copy protection systems may interfere with the closed captioned signal.
- If using an indoor antenna or if TV reception is very poor, the closed caption decoder may not appear or may appear with strange characters or misspelled words. In this case, adjust the antenna for better reception or use an outdoor antenna.

NOTICE OF POSSIBLE ADVERSE EFFECTS ON TV PICTURE DISPLAY

Avoid displaying stationary images on your TV screen for extended periods of time. Fixed (non-moving) patterns or images (including but not limited to PIP/POP windows, closed captions, video game patterns, TV station logos, stock tickers, websites, and special formats that do not use the entire screen) can become permanently ingrained in the cathode ray tube(s) of the TV and cause subtle but permanent ghost images. **This type of damage is NOT COVERED BY YOUR WARRANTY.** See item 33 on page 4.

Programming your favorite channels

You can preset up to 12 of your favorite channels using the Favorite Channel Programming feature. Because this feature scans through only your favorite channels, it allows you to skip other channels you do not normally watch.

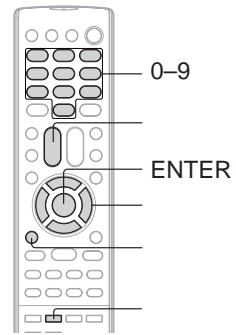

Programming your favorite channels

- 1** Select a channel you want to program as a favorite channel.

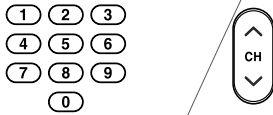

Repeat steps 1-4 for up to 12 channels.

- 2** Press MENU in the TV/VCR mode, then press ◀ or ▶ to select OPTION menu, then press ▲ or ▼ to select "FAVORITE CH".

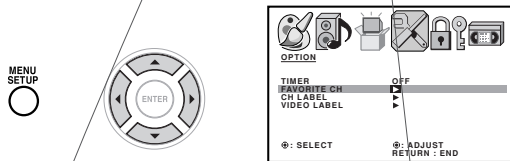

- 3** Press ◀ or ▶ to display the FAVORITE CH menu.

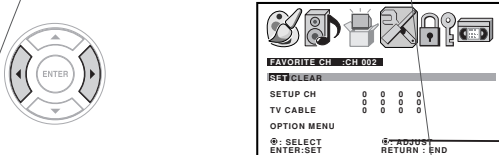

TV operation

Labeling

1 Press **CH LABEL** on the remote control. The channel label menu screen appears.

Press **ENTER** to select the channel label you want to edit. The channel label menu screen appears.

2 Press **ENTER** to select the channel label you want to edit. The channel label menu screen appears.

Press **ENTER** to select the channel label you want to edit. The channel label menu screen appears.

3 Press **ENTER** to select the channel label you want to edit. The channel label menu screen appears.

Press **ENTER** to select the channel label you want to edit. The channel label menu screen appears.



If you want to edit the channel label, select the channel label you want to edit.

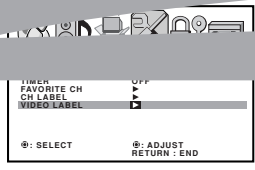

2 Press **◀** or **▶** to display the VIDEO LABEL menu. Press **▲** or **▼** to select the video source you want to label, then press **◀** or **▶** to select label name.

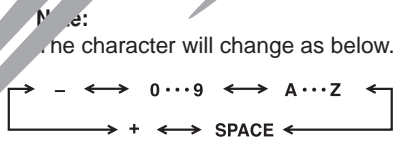

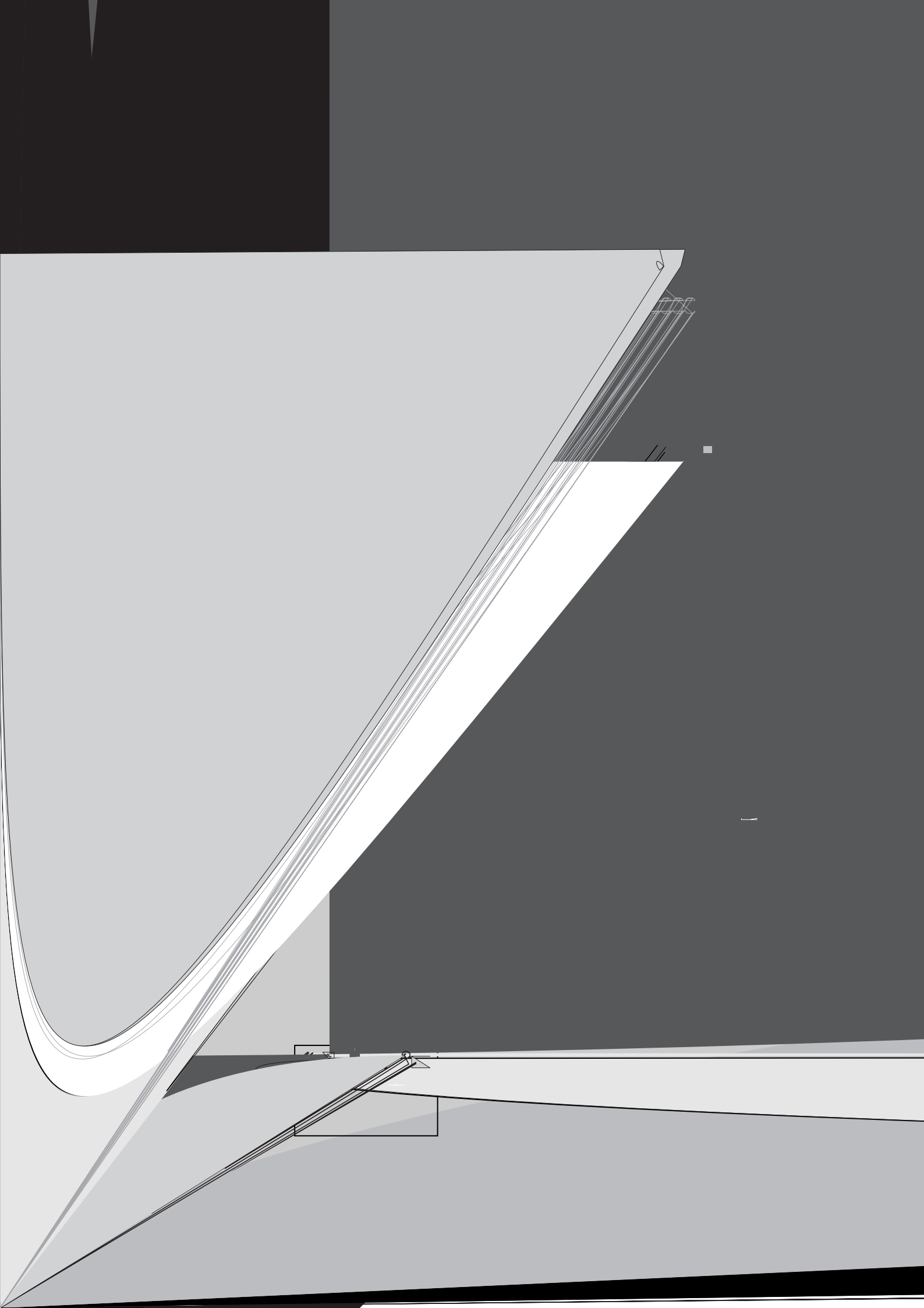

Setting the V-Chip (continued)

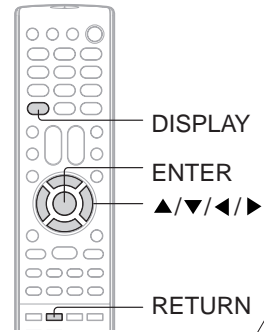

To set the V-Chip

1 In the LOCKS menu, press ▲ or ▼ to select “TV RATING”, then press ◀ or ▶ to select the desired setting.

- OFF : TV RATING is not set
- G : All children
- PG : 7 years old and above
- TV : General audience
- TV-14 : Parental guidance
- TV-14 : 14 years old and above
- TV-MA : 17 years old and above

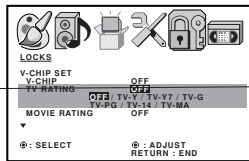
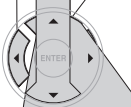

TV-Y7, TV-PG, TV-14 or TV-MA, view the contained rating. Select the desired item you

2 Press ENTER to confirm the “TV RATING”, then press RETURN to exit the menu.



- OFF : M
- G : All
- PG : Pare
- PG-13 : Paren
- R : Under 1
- TV-14 : Parental g
- NC17 : 17 years old
- X : Adult only

3 Press ▲ or ▼ to select “V-CHIP”.

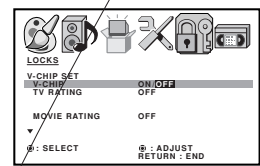

4 Press ◀ or ▶ to select “ON”. Now your settings were set into the memory.

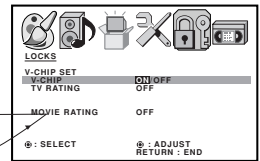

5 Press RETURN to make the menu screen disappear.



To use after the TV is protected

When the program applied to the V-Chip setting is received, enter the password, then press ENTER. Protection can be canceled.

Note:

The V-Chip function is activated only on programs that have the rating signal.

Locking the channels

With the CH LOCK feature, you can lock specific channels. You will not be able to tune locked channels unless you clear the setting. You can choose to lock up to nine TV channels and nine cable channels.

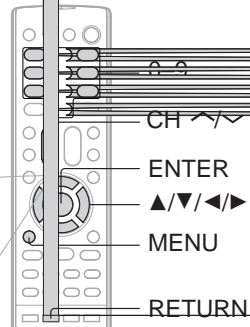

Locking the channels

1 Select a channel you want to lock.

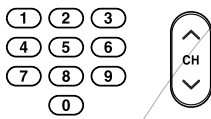

2 Press MENU in the TV/VCR mode, then press ◀ or ▶ to select LOCKS menu. Press ▲ or ▼ to display the password entering mode.

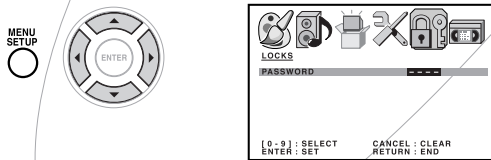

3 Use the Number buttons (0-9) to enter your password, then press ENTER. The LOCKS menu appears.

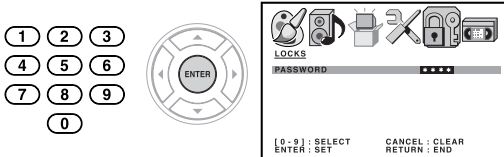

4 Press ▲ or ▼ to select "CH LOCK" and press ◀ or ▶ to display the CH LOCK menu.

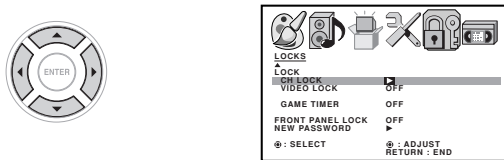

5 Press ◀ or ▶ to select "SET", then press ENTER.

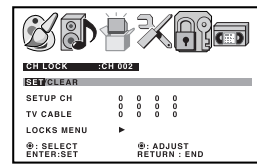

If you return to LOCKS menu, select "LOCKS MENU" then press ▶.

6 Repeat steps 1 through 5 to lock other channels.

7 Press RETURN to make the menu screen disappear.



Notes:

- To unlock channels:** Follow above steps 1~4, then press ◀ or ▶ to select "CLEAR" and clear all channels from the list of locked channels. Press ENTER. Press RETURN to make the menu screen disappear.
- After programming CH LOCK, change channels before turning off the television.

TV operation

Press
or to select LOCKS

. disappear

5

Press RETURN to make the menu screen

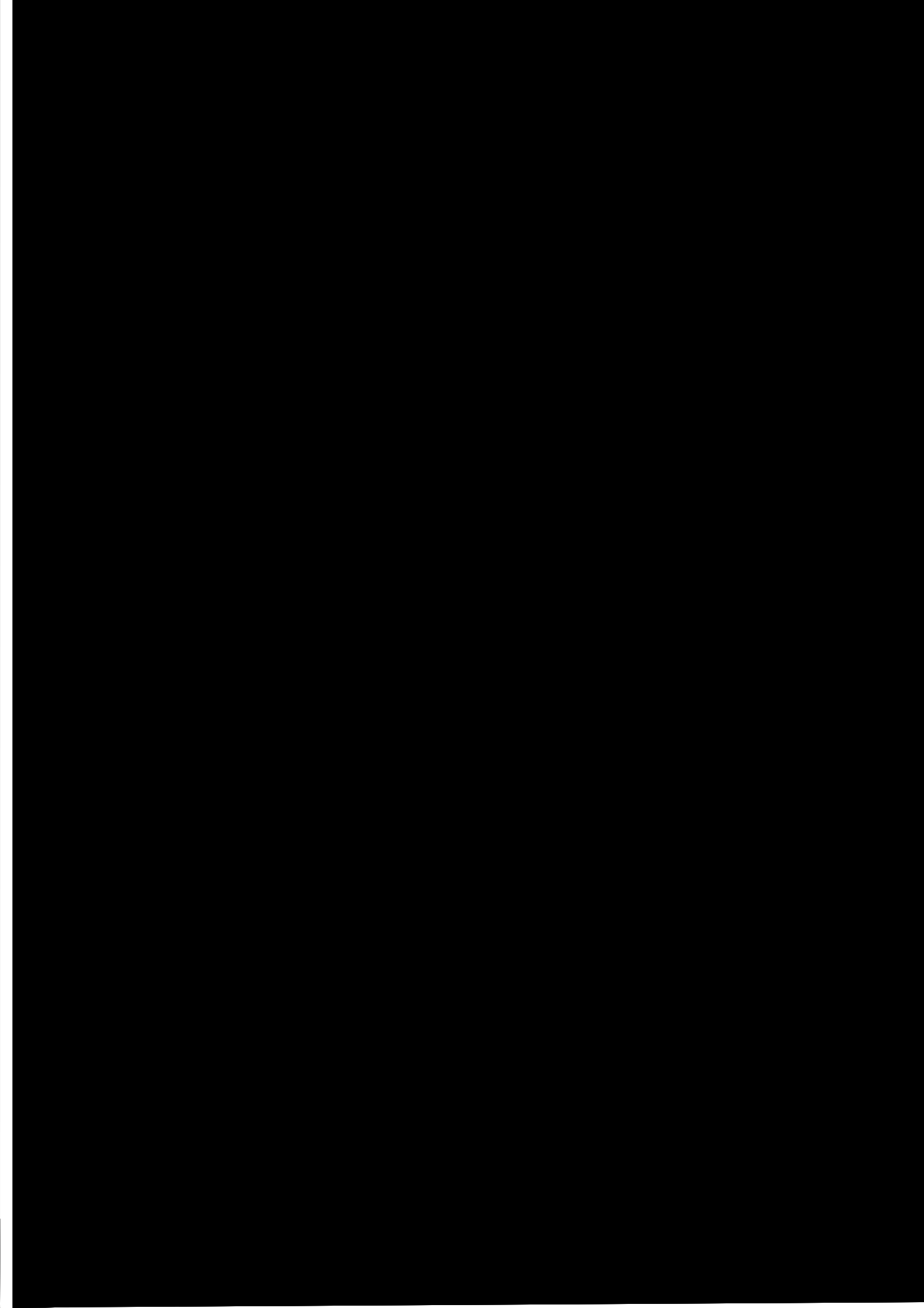



THRESH 7.000

ADJUST SELECT

TURN

To set
This
pre
aut

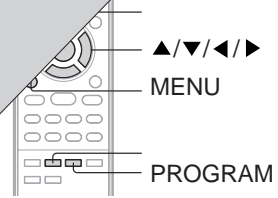

To set

EXAMP

to select "OFF TIMER", then
select the hour position.



If you return to OPTION menu,
select "OPTION MENU" then press
▶.

3 Press ▲ or ▼ to set the desired hour, then
press ▶.

4 Set the desired minutes, as in step 3.



5 Press ◀ or ▶ to select "ONCE" or "DAILY"



6 Press MENU repeatedly until the menu screen
is cleared.



- Notes:**
- **To cancel the OFF TIMER function:**
To cancel OFF TIMER, select "CLEAR" in step 5 above, then
press **RETURN** to make the menu screen disappear.
 - **To confirm the ON/OFF TIMER:**
Press **PROGRAM** twice to indicate the programs on the
screen.

TV operation

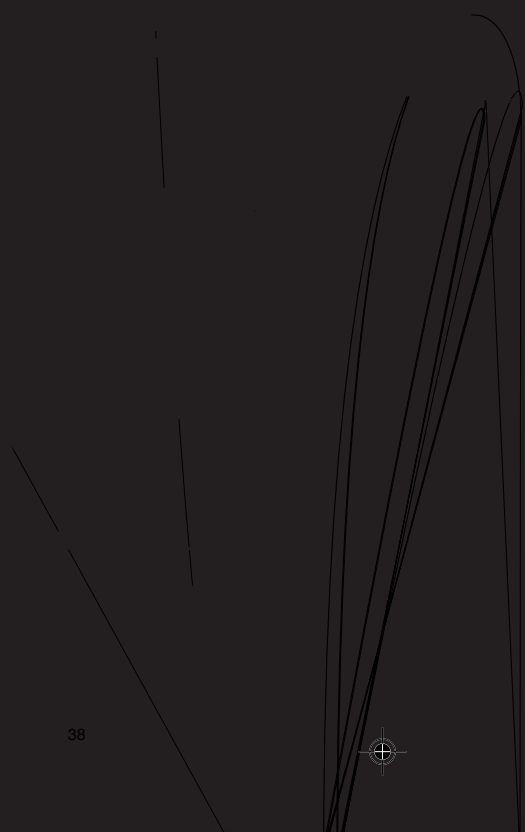



Using the CableClear® feature/ Selecting the color temperature

CableClear® reduces visible interference in your TV picture. This is useful when receiving a broadcast with a weak signal (especially a Cable channel) or playing a video cassette or disc damaged by repeated use.

Change the picture quality by selecting from three preset color temperatures—cool, medium, and warm.

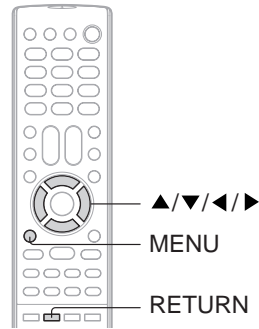

Using the CableClear® feature

- 1 Press MENU in the TV/VCR mode, then press ◀ or ▶ to select PICTURE menu.

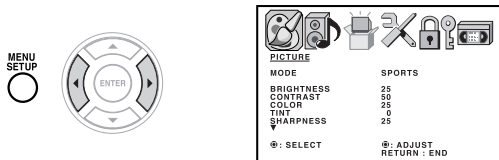

- 2 Press ▲ or ▼ to select "CableClear".

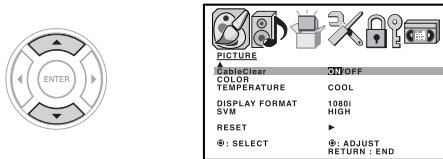

- 3 Press ◀ or ▶ to select "ON" or "OFF".

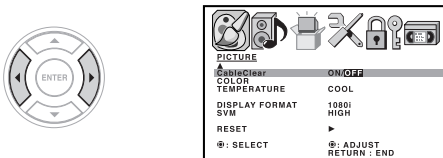

- 4 Press RETURN to make the menu screen disappear.



Selecting the color temperature

- 1 Press MENU in the TV mode, then press ◀ or ▶ to select PICTURE option.

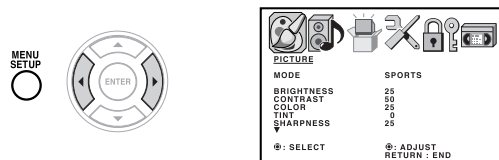

- 2 Press ▲ or ▼ to select "COLOR TEMPERATURE".

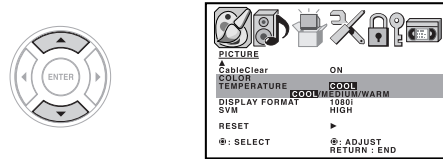

- 3 Press ◀ or ▶ to select the mode you prefer.

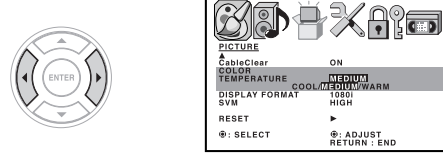

Mode	Picture quality
COOL	Blueish
MEDIUM	Neutral
WARM	Reddish

- 4 Press RETURN to make the menu screen disappear.



TV operation

SPORTS	
WITNESS	25
FAST	50
WITNESS	25
WITNESS	0
WITNESS	25
SELECT	@: ADJUST RETURN - END

@: ADJUST
RETURN - END



PI





Selecting the picture size (continued)

You can view 480i and 480p format programs in a variety of picture sizes—Natural, TheaterWide 1, TheaterWide 2, TheaterWide 3, and Full. The way the image displays in any of the picture sizes will vary depending on the format of the program you are viewing. Select the picture size that displays the current program the way that looks best to you.

NOTICE OF POSSIBLE ADVERSE EFFECTS ON TV PICTURE DISPLAY

Avoid displaying stationary images on your TV screen for extended periods of time. Fixed (non-moving) patterns or images (including but not limited to PIP/POP windows, closed captions, video game patterns, TV station logos, stock tickers, websites, and special formats that do not use the entire screen) can become permanently ingrained in the cathode ray tube(s) of the TV and cause subtle but permanent ghost images. **This type of damage is NOT COVERED BY YOUR WARRANTY.** See item 33 on page 4.

Selecting the picture size

■ Natural picture size

- The image is displayed close to its originally formatted proportion. Some program formats will display with side bars and/or bars at the top and bottom.

Natural picture size example: The way the image displays will vary depending on the format of the program you are currently watching.

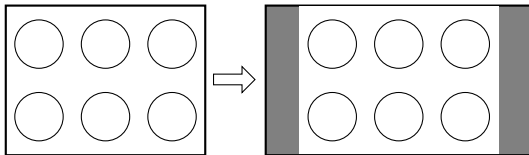

Conventional (4:3) picture on a conventional TV screen

Conventional (4:3) picture in Natural size on your wide-screen TV

■ TheaterWide 1 picture size (for 4:3 format programs)

- The center of the picture remains close to its original proportion, but the left and right edges are stretched wider to fill the screen.
- The top and bottom edges of the picture may be hidden; however, this mode cannot be scrolled.

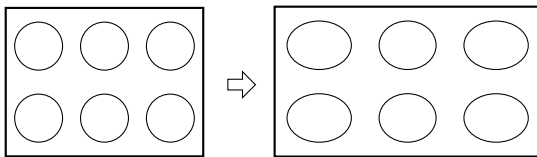

TheaterWide 1 picture size example

Using these functions to change the picture size (i.e., changing the height/width ratio) for any purpose other than your private viewing may be prohibited under the Copyright Laws of the United States and other countries, and may subject you to civil and/or criminal liability.

■ TheaterWide 2 picture size (for letter box programs)

- The picture is stretched the same amount both wider and taller (retains its original proportion).
- The top and bottom edges of the picture may be hidden. To view the hidden areas, see "Picture scroll" on the next column.

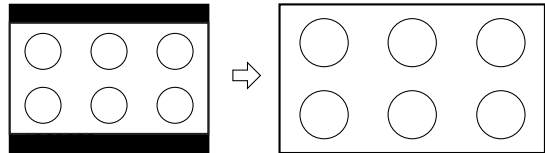

■ TheaterWide 3 picture size (for letter box programs with subtitles)

- The picture is stretched wider to fill the width of the screen, but only slightly stretched taller.
- The top and bottom edges of the picture may be hidden. To view the hidden areas (such as subtitles or captions), see "Picture scroll" on the next column.

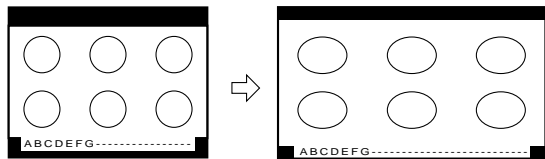

■ Full picture size (for 16:9 source programs)

- If receiving a 4:3 format program, the picture is stretched wider to fill the width of the screen, but not stretched taller.
- None of the picture is hidden.

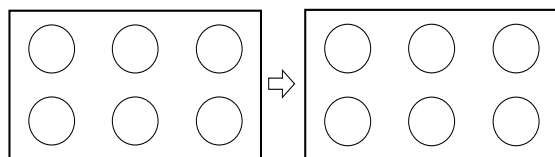



TV operation



Item you want to
to adjust the setting.

Press ◀ or ▶ to select "ON" or "OFF".
If the feature is not available,
the feature is not available.
Press ◀ or ▶ to adjust the bass sound.
Press ◀ or ▶ to adjust the treble sound.
Press ◀ or ▶ to obtain an equal sound level
from both speakers.
Press ◀ or ▶ to select "ON" or "OFF".
Stable Sound® feature limits the highest volume
level to prevent extreme changes in volume
when the signal source is changed.
The feature maintains the original
normal sound.
Press ◀ or ▶ to select "ON" or "OFF".
The feature maintains the original
dynamic presence and sound created offers
a thoroughly enjoyable listening experience.
The feature maintains the original
normal sound.

Press the [M] key to make the menu screen



RETURN

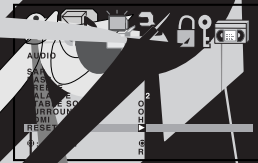

3 Press RETURN to make the menu screen disappear.

4 Press RETURN to make the menu screen disappear.





Loading and unloading a cassette tape

Use only video cassette tapes marked **VHS**.

Loading

Push the center of the tape until it is automatically inserted.



Insert the cassette tape with its labeled side facing up and the erase prevention tab positioned at your left. An inverted cassette tape cannot be inserted.

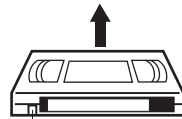

Erase prevention tab

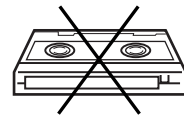

Automatic power ON

When you insert a cassette tape the unit power will turn ON automatically.

Automatic playback

When loading a cassette tape without an erase prevention tab, playback will start automatically.

Unloading

1 Press **STOP/EJECT** on the front panel or **EJECT** on the remote.



or



2 Remove the cassette tape.

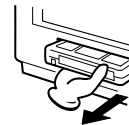

Automatic tape eject

This unit will automatically rewind the tape when the tape has ended. And when the tape is rewinded to its beginning, the cassette tape will be ejected automatically.

Notes:

- Always eject the tape when not in use.
- The cassette tape can be ejected even if the POWER is "OFF".

To prevent accidental erasure

To prevent accidental erasure

Remove the erase prevention tab with a screwdriver.

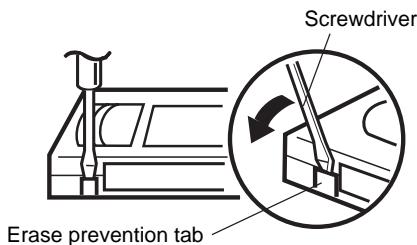

To record again

Cover the hole with a piece of adhesive tape.

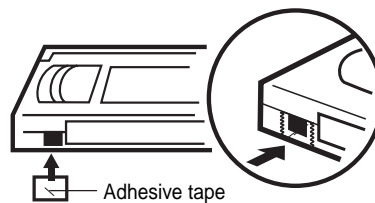

Tape speed and maximum recording time

Tape Speed	Video cassette tape				
	T-160	T-120	T-90	T-60	T-30
SP (Standard Play)	2-2/3 hours	2 hours	1-1/2 hours	1 hour	30 minutes
SLP (Super Long Play)	8 hours	6 hours	4-1/2 hours	3 hours	1-1/2 hours





Playback (VCR)

Special playback

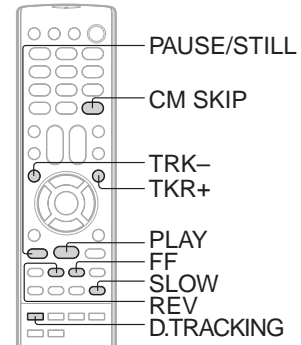

Picture search

Reverse picture search function

Press **REV** once or twice during the playback.

Forward picture search function

Press **FF** once or twice during the playback.

To return to playback, press **PLAY**.

SPEED SEARCH TIMES

TAPE SPEED	PICTURE SEARCH SPEED	
	PRESS ONCE	PRESS TWICE
SP (Standard Play)	3 X	5 X
SLP (Super Long Play)	9 X	15 X

Still picture

Press **PAUSE/STILL** during playback.

To resume normal playback, press **PLAY** or **PAUSE/STILL**.

If the still picture jitters excessively, press **TRK + / -** to stabilize the still picture.

Slow motion

During playback press **SLOW**.

To return to playback, press **PLAY**.

■ Slow tracking and vertical lock adjustment

If noise bars appear in the picture during slow motion, press the **TRK + / -** to reduce the noise bars.

Frame by frame picture

Press **PAUSE/STILL** during playback.

Press **SLOW** one by one: The picture advances frame by frame.

To return to playback, press **PLAY** or **PAUSE/STILL**.

CM skip

Press **CM SKIP** during playback. The unit will search forward through approximately 30 seconds of the tape (e.g. unwanted commercial time) for each press of **CM SKIP** (maximum six presses) and then resume normal playback.

For example : 1 press: 30 seconds of tape
 2 press: 60 seconds of tape
 3 press: 90 seconds of tape

Digital tracking controls

When a tape is played, the Digital Auto Tracking system automatically adjusts the tracking to obtain the best possible picture. If noise bars appear during playback, adjust the tracking manually as follows:

- Press **TRK + / -** to obtain the best possible picture. "MANUAL TRACK" will appear for 4 seconds on the screen. To resume automatic tracking, press **D.TRACKING**. "DIGITAL TRACK" will appear for 4 seconds on the screen.

Notes:

- "SP" is more appropriate as less noise appeared during search and still playback for tape recorded in SP.
- The audio output is muted during PICTURE SEARCH, STILL, FRAME ADVANCE and SLOW MOTION.
- During picture search mode there will be noise bars which are caused by the system.
- The Special Playback will automatically change to playback after approx. 5 minutes to protect the video tape against excessive wear.



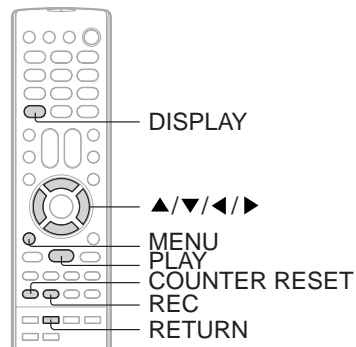

Convenient function

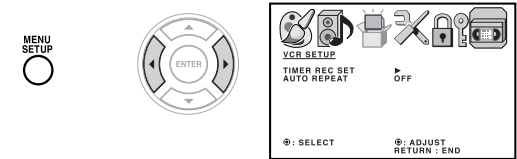
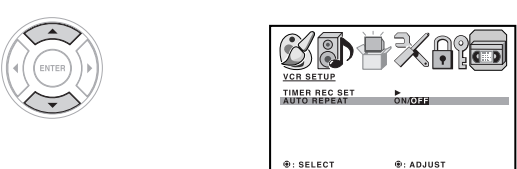
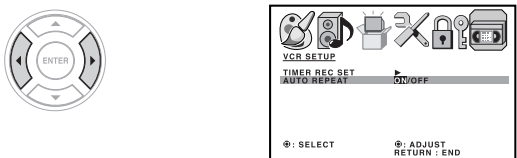

Repeat playback

The entire video tape will be played until its end. The tape will automatically rewind to the beginning and the playback will be repeated.



- 1 Press MENU in the TV/VCR mode, then press ◀ or ▶ to select VCR SETUP menu.**

- 2 Press ▲ or ▼ to select "AUTO REPEAT".**

- 3 Press ◀ or ▶ to select "ON" or "OFF".**
 If "ON" is selected, the playback will be repeated endlessly.

- 4 Press RETURN to make the menu screen disappear.**
 If you press DISPLAY, "⏪" will appear on the screen [24].

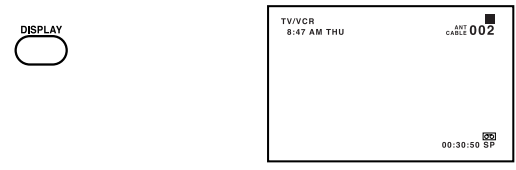
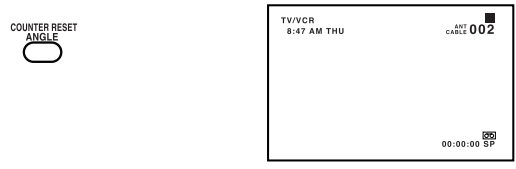
- 5 To start the playback, press PLAY.**
 The playback will be repeated endlessly.

■ To cancel repeat mode:

In step 3 above, press ◀ or ▶ to select "OFF" position. Press RETURN to make the menu screen disappear. The repeat function is canceled automatically when the unit is switched off.

Using the real time tape counter

The on-screen real time tape counter shows the tape running time in hours, minutes and seconds. You can easily determine how long the tape has been running or how much time is left on the tape.

- 1 Press DISPLAY.**

- 2 Press COUNTER RESET to set the counter to "00:00:00".**

- 3 Begin Playback or Recording to start the tape, the counter will display the elapsed time.**

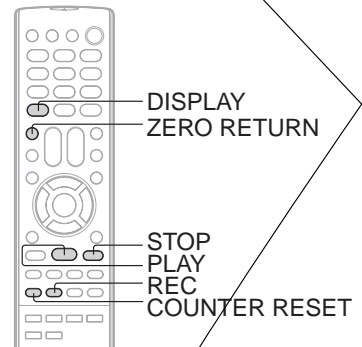
- 4 When you wish to make the counter disappear, press DISPLAY once again.**



Playback (VCR)



Zero return function

The zero return function provides a convenient method of rapidly returning to the starting point of recording or playback. The starting point can be indexed for any location on the tape by pressing **COUNTER RESET** and **ZERO RETURN**.

1 Press DISPLAY.



2 Before playback or recording, press COUNTER RESET to set the counter to "00:00:00".

ording.

URN. The tape will rewind and stop at the "00:00:00" position.

Video head cleaning

■ Video head clogging

The video heads are the means by which the unit reads the picture from the tape during playback. In the unlikely event that the heads become dirty enough to be clogged, no picture will be played back. This can easily be determined if, during playback of a known good tape, there is good sound, but no picture (picture is extremely snowy). If this is the case, have the unit checked by qualified service personnel.



Good Picture



Snowy Picture

■ Video head cleaning

Video head cleaning is needed when the playback picture becomes unclear. This signifies that the heads are getting dirty and can occur when playing poor quality or damaged tapes. If the heads require cleaning, use an equivalent high quality chemical non-abrasive (wet) head cleaning tape or have them cleaned professionally. If playing a head cleaning tape in the unit once does not improve the picture, play it several times before requesting service.

Notes:

- DO NOT ATTEMPT TO CLEAN THE VIDEO HEADS OR SERVICE THE UNIT BY REMOVING THE REAR COVER.
- Video heads may eventually wear out and should be replaced when they fail to produce clear pictures.
- To help prevent video head clogging, use only good quality VHS tapes. Discard worn out tapes.

Recording a TV program

Recording and viewing the same TV program.

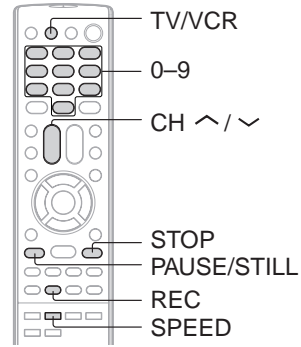

Recording a TV program

1 Load a cassette tape with the erase prevention tab intact.
The unit will automatically turn on.

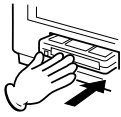

2 Press SPEED to select the desired tape speed SP or SLP.

The tape counter and SP or SLP will appear on the screen for about 4 seconds.



00:00:00 SP

3 Select "TV" or "CABLE" to the appropriate position 28.

TV - VHF/UHF channels
CABLE - Cable TV channels

4 Press Direct channel selection (0-9) or CH ^/∨ to select the channel to be recorded.

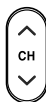
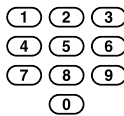

CABLE 110

5 Press REC.

"●" will appear on the screen for about 4 seconds and the REC/OTR indicator on the front panel will light.



CABLE 110

Notes:

- If power is switched off during recording, the TV and the DVD sections go off and the VCR continues to record. Press **STOP** to halt the recording and turn off the VCR.
- The unit channel cannot be changed during recording.
- If you record the TV program after the DVD playback, you must set the unit to TV/VCR mode using **TV/VCR**.

To stop recording

Press **STOP** to stop recording.

"■" will appear on screen for about 4 seconds.



To stop recording temporarily

Press **PAUSE/STILL** to avoid recording unwanted material.

"||" will appear on the screen and the REC/OTR indicator will blink on and off. Press **PAUSE/STILL** or **REC** to continue the recording.

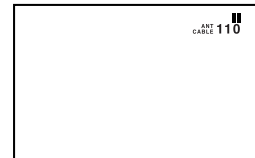

Note:

The pause function will be released after 5 minutes to prevent damage to the tape or the unit. The unit will change to the STOP mode.

Auto Rewind feature

This VCR will automatically rewind the tape when the tape has ended (except during OTR and timer recording). It will also eject the tape.

Note:

If the erase prevention tab is removed, the tape will eject when **REC** is pressed for recording.

The unauthorized recording, use, distribution, or revision of television programs, videotapes, DVDs and other materials, is prohibited under the Copyright Laws of the United States and other countries, and may subject you to civil and/or criminal liability.

Recording (VCR)

One-touch Timer Recording (OTR)

The One-touch timer recording feature provides a simple and convenient way to make a timed recording.

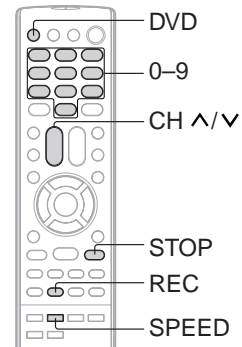

One-touch timer recording (OTR)

Example: One-touch timer recording for 30 minutes.

1 Load a cassette tape with the erase prevention tab intact.



The unit will automatically turn on.

2 Press **SPEED** to select the desired tape speed **SP** or **SLP**.

The tape counter and SP or SLP will appear on the screen for about 4 seconds.



3 Set "TV" or "CABLE" option to the appropriate position **28**.

TV - VHF/UHF channels
CABLE - Cable TV channels

4 Press Direct channel selection (0-9) or CH ^/v to select the channel to be recorded.

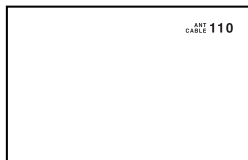
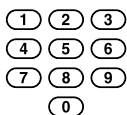

5 Press **REC** to begin recording. Press the button again to stop recording after 30 minutes. Each additional press of **REC** will increase recording time as shown below, up to a maximum of 6 hours. "OTR" will appear on the screen.

Press	Recording time	Press	Recording time
once	NORMAL REC	6 times	3:00
twice	0:30	7 times	4:00
3 times	1:00	8 times	5:00
4 times	1:30	9 times	6:00
5 times	2:00	10 times	NORMAL REC

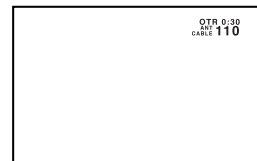

To cancel OTR

Press **STOP**.



"■" will appear on screen for about 4 seconds.

Notes:

- If you wish to watch the DVD playback during the recording or the OTR, press **DVD** to change to DVD mode and perform the DVD playback **57**.
- The channel cannot be changed during recording.

The unauthorized recording, use, distribution, or revision of television programs, videotapes, DVDs and other materials, is prohibited under the Copyright Laws of the United States and other countries, and may subject you to civil and/or criminal liability.

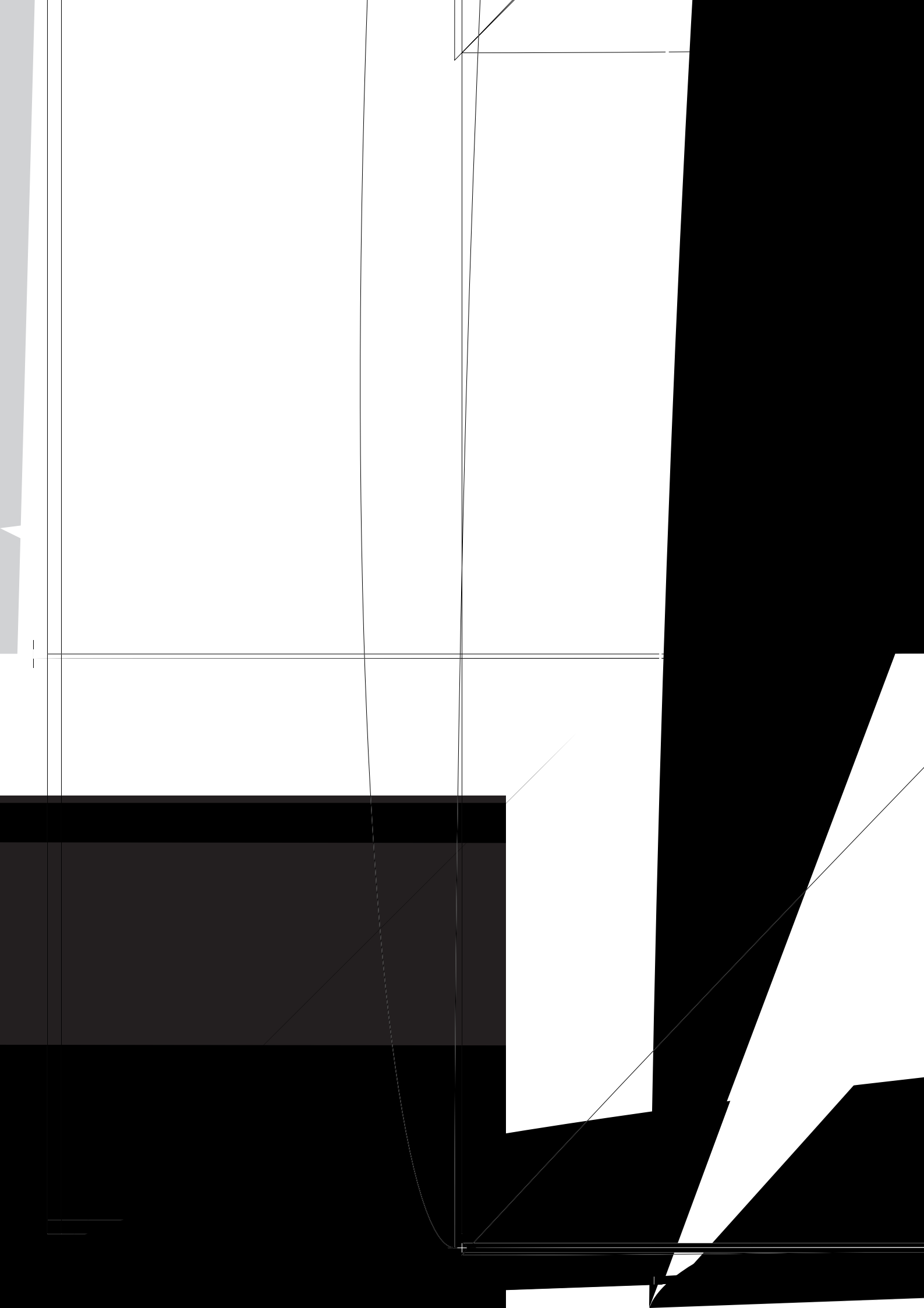

Timer recording (continued)

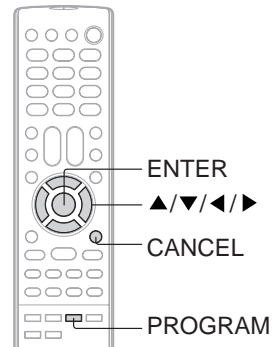

To set daily/weekly timer

Weekly (e.g. WKL-TUE: each Tuesday) or daily (e.g. MON-SAT: Monday to Saturday) Timer recording
 Follow the procedure of timer recording on the previous page. At step 4 press ◀ or ▶ repeatedly until the desired setting appears. Then press **ENTER**.

When you press ◀ repeatedly, the indicator at DATE will change as follows, in this case the day is Friday.

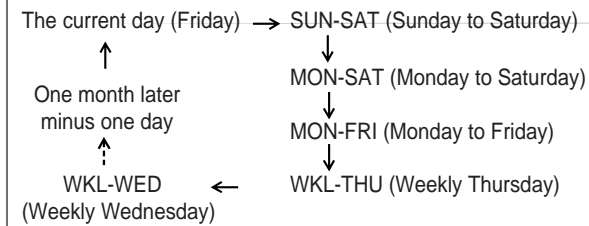

If the programs overlap another

Do not overlap timer programs as portions of the conflicting programs will be lost. The first recording time has priority over the next recording time as shown in the diagram below.

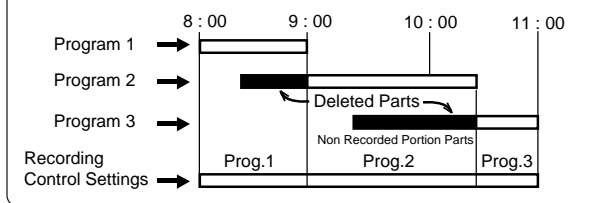

- Notes:**
- The daily/weekly recording can be made continuously until the recording is canceled or the tape reaches the end.
 - During timer recording the automatic rewinding mechanism does not function.
 - You can correct or cancel the programmed setting in program confirm mode.

To confirm the settings

Press **PROGRAM** once. The TV screen displays the timer program list. Press **PROGRAM** again. The TV screen displays the ON/OFF timer setting.

Press **PROGRAM** 3 times. The menu screen is cleared.

(once)

DATE	START	END	CH	SPEED
23 TH	7:00PM	9:30PM	125	SLP
---	---	---	---	---
---	---	---	---	---
---	---	---	---	---
---	---	---	---	---
---	---	---	---	---
---	---	---	---	---
---	---	---	---	---

VCR SETUP ▶

Ⓢ: SELECT CANCEL: DELETE
 ENTER: SET RETURN: END

(twice)

To cancel a program

Press **PROGRAM** once. The TV screen displays the timer program list.
 Press ▲ or ▼ to select the unnecessary program, and press **CANCEL** to cancel the program.

PROGRAM REPEAT A-B
 DVD/CARD

DATE	START	END	CH	SPEED
23 TH	7:00PM	9:30PM	125	SLP
24 WE	8:00PM	9:00PM	120	SLP
26 SA	10:00AM	10:30AM	120	SLP
26 SA	7:00PM	9:00PM	007	SLP
27 SU	8:30PM	9:00PM	018	SLP
28 MO	6:00PM	6:30PM	001	SLP
29 TU	11:00PM	11:20PM	110	SLP
31 WE	7:30PM	9:00PM	125	SLP

VCR SETUP ▶

Ⓢ: SELECT CANCEL: DELETE
 ENTER: SET RETURN: END

CANCEL

DATE	START	END	CH	SPEED
23 TH	7:00PM	9:30PM	125	SLP
24 WE	8:00PM	9:00PM	120	SLP
26 SA	10:00AM	10:30AM	120	SLP
27 SU	8:30PM	9:00PM	018	SLP
28 MO	6:00PM	6:30PM	001	SLP
29 TU	11:00PM	11:20PM	110	SLP
31 WE	7:30PM	9:00PM	125	SLP

VCR SETUP ▶

Ⓢ: SELECT RETURN: END
 ENTER: SET

Duplicating a video tape

If you connect the unit to another VCR or Camcorder, you can duplicate a previously recorded tape. Make all connections before turning on the power.

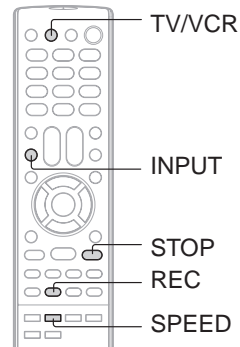

Duplicating a video tape

Preparation:

- Press **TV/VCR** to select the TV/VCR mode.
- Load a cassette tape with the erase prevention tab intact.
- Load a previously recorded tape into the playback VCR or Camcorder.

1 Press **SPEED** to select the desired tape speed **SP** or **SLP**.



It is recommended that you set the Speed to the SP mode on the recording VCR for best results.

2 Press **INPUT** repeatedly to select **AUDIO/VIDEO** input position.

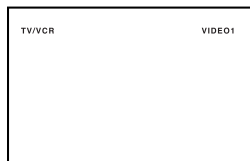

VIDEO1: on the rear panel
VIDEO2: on the front panel

3 Press **REC**.



4 Press **PLAY** on the playback VCR or camcorder.

5 Press **STOP** after duplicating a video tape.



The unauthorized recording, use, distribution, or revision of television programs, videotapes, DVDs and other materials, is prohibited under the Copyright Laws of the United States and other countries, and may subject you to civil and/or criminal liability.

Connection with second video recorder

- Select "VIDEO1" on step 2.

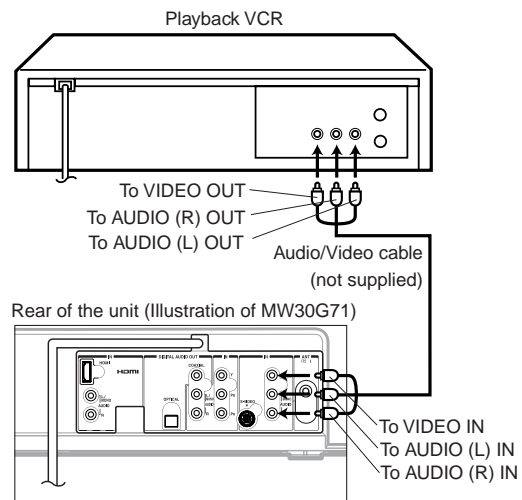

Connection with Camcorder

- Select "VIDEO2" on step 2.

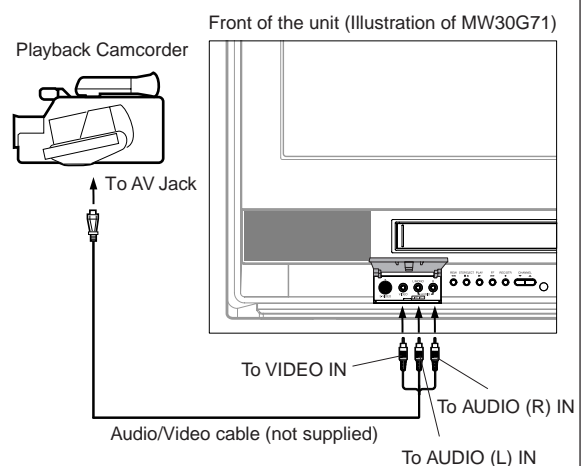

For duplicating a previously recorded tape from a camcorder, follow the camcorder manufacturer's instructions. A typical camcorder dubbing hookup is shown above.

Recording a DVD/CD disc

You can record disc material in DVD, Audio CD, etc. onto a video tape with this unit.

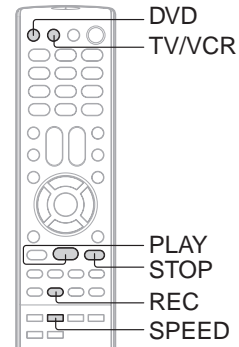

Duplicating a DVD or CD disc

Preparation:

- Press **TV/VCR** to select the TV/VCR mode.
- Load a cassette tape with the erase prevention tab intact.
- Load a DVD/CD disc.

1 Press **SPEED** to select the desired tape speed **SP** or **SLP**.



2 Press **DVD** to select the DVD mode.



3 Press **PLAY** to start playback.



4 Press **REC** to start recording.



The unit will change to the VCR mode automatically and the playback picture or sound will be duplicated on the video cassette tape.

5 Press **STOP** if you finish recording.



If you wish to stop a DVD/CD disc, press **DVD** to change the DVD mode, then press **STOP**.

Notes:

- You may not record the beginning of the disc, so start to playback the disc, then start to record.
- You cannot record the disc with copy guard function. "DVD IS COPY PROTECTED" will show up on the TV screen for approx. 4 seconds.

The unauthorized recording, use, distribution, or revision of television programs, videotapes, DVDs and other materials, is prohibited under the Copyright Laws of the United States and other countries, and may subject you to civil and/or criminal liability.

Playing a disc

This section shows you the basics on how to play a disc.

Illustration of MW30G71

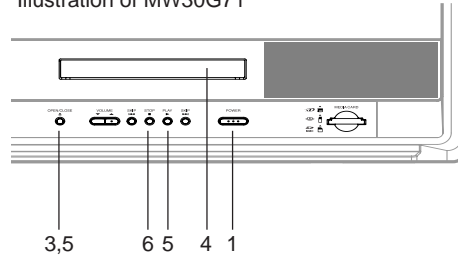

CAUTION

Keep your fingers well clear of the disc tray as it is closing. Neglecting to do so may cause serious personal injury.

DVD VCD CD Basic playback

Preparations:

- Insert the AC cord plug into a standard 120V 60Hz polarized AC outlet. If the AC cord plug is plugged in for the first time, you need to set "Starting setup" [20].
- When connecting to other equipment, turn power off.

1 Press POWER on the unit or on the remote to turn on the unit.
 The Power indicator will light.

- Every time you press **POWER**, the unit starts from TV mode.
- When using an amplifier, switch on the amplifier.



2 Press DVD to select DVD mode.
 The DVD startup screen will appear on the screen. "Reading Disc" display will change to "No Disc". (If DVD disc has already loaded, playback will start automatically.)



3 Press OPEN/CLOSE.
 The disc tray opens.



4 Place the disc on the disc tray.

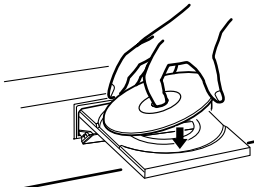

With the playback side down

- There are two different disc sizes. Place the disc in the correct guide on the disc tray. If the disc is out of the guide, it may damage the disc and cause the unit to malfunction.
- Do not place a disc which is unplayable on the disc tray.

5 Press OPEN/CLOSE or PLAY.
 The disc tray closes automatically. On the TV-screen, "▲" changes to "Reading Disc" and then playback commences.



- A menu screen will appear on the TV screen, if the disc has a menu feature. Press ▲/▼ or ◀/▶ to select title, then press ENTER. Title is selected and play commences.

6 Press STOP to end playback.

- **Resuming facility**
 - The unit records the stopped point, depending on the disc. "■" appears on the screen. Press **PLAY** to resume playback (from the scene point).
 - If you press **STOP** again or unload the disc ("■" appears on the screen.), the unit will clear the stopped point.



- **To start playback in the stop mode**
 Press **PLAY**.



Note:
If the unit does not operate properly:
 Static electricity, etc., may affect the player's operation. Disconnect the AC power cord once, then connect it again.

Basic playback (DVD)

Playing a disc (continued)

Basic playback

■ To pause playback (still mode)

Press **PAUSE/STILL** during playback.



To resume normal playback, press **PLAY**.

- The sound is muted during still mode.

■ To stop playback

Press **STOP**.



■ To remove the disc

Press **OPEN/CLOSE**.



Remove the disc after the disc tray opens completely.

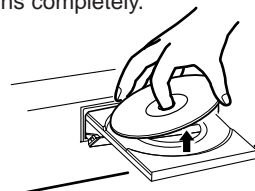

Be sure to press **OPEN/CLOSE** to close the disc tray after you remove the disc.





Notes:

- If a non-compatible disc is loaded, "Incorrect Disc", "Region Code Error" or "Parental Error" will appear on the TV screen according to the type of loaded disc. In this case, check your disc again (see pages 9 and 73).
- Some discs may take a minute or so to start playback.
- When you set a single-faced disc label downwards (i.e. the wrong way up) and press **OPEN/CLOSE** or **PLAY** on the unit, "Reading Disc" will appear on the display for a few minutes and then "Incorrect Disc" will continue to be displayed.
- Some discs may not work the resuming facility.
- Resuming cannot function when you play a PBC-featured Video CD while the PBC is on. To turn off the PBC, see page 65.
- Some playback operations of DVDs may be intentionally fixed by software producers. Since this unit plays DVDs according to the disc contents the software producers designed, some playback features may not be available. Also refer to the instructions supplied with the DVDs.
- Do not move the unit during playback. Doing so may damage the disc.
- Use **OPEN/CLOSE** to open and close the disc tray. Do not push the disc tray while it is moving. Doing so may cause the unit to malfunction.
- Do not push up on the disc tray or put any objects other than discs on the disc tray. Doing so may cause the unit to malfunction.
- In many instances, a menu screen will appear after playback of a movie is completed. Prolonged display of an on-screen menu may damage your television set, permanently etching that image onto its screen. To avoid this, be sure to press **POWER** on your remote control once the movie is completed.
- There may be a slight delay between you pressing the button and the function activating.
- If the Media card is inserted during the playback, playback will stop and change to the CARD mode automatically. If you wish to change to the DVD mode, press **DVD/CARD**.

■ To obtain a higher quality picture

Occasionally, some picture noise not usually visible during a normal broadcast may appear on the TV screen while playing a DVD video disc because the high resolution pictures on these discs include a lot of information. While the amount of noise depends on the TV you use with this unit, you should generally reduce the sharpness adjustment on your TV when viewing DVD video discs.

■ About

The     icons on the heading bar show the playable discs for the function described under that heading.

 : You can use this function with DVD video discs.

 : You can use this function with Video CDs.

 : You can use this function with Audio CDs and CD-R/RW CDs.

 : You can use this function with Media cards.

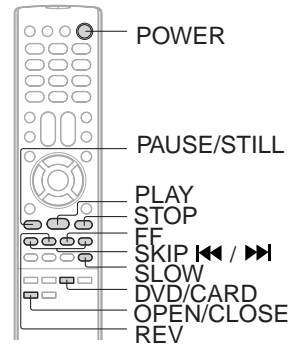

DVD VCD CD Playing in fast reverse or fast forward directions

Press **REV** or **FF** during playback.

REV: Fast reverse playback
FF: Fast forward playback

Each time you press **REV** or **FF**, the playback speed changes.

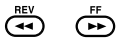

■ **To resume normal playback**
Press **PLAY**.



Notes:

- The unit mutes sound and subtitles during reverse and forward scan of DVD/VCD video discs. However, the unit plays sound during fast forward or fast reverse play of audio CDs.
- The playback speed may differ depending on the disc.

DVD VCD Playing frame by frame

Press **PAUSE/STILL** during still playback.

Each time you press **PAUSE/STILL**, the picture advances one frame.



■ **To resume normal playback**
Press **PLAY**.



Note:

The sound is muted during frame by frame playback.

DVD VCD Playing in slow-motion

Press **SLOW** during playback.

Each time you press the button, the slow-motion speed changes.



■ **To resume normal playback**
Press **PLAY**.



Note:

The sound is muted during slow-motion playback.

DVD VCD CD Locating a chapter or track

Press **SKIP <<<** or **>>>** repeatedly to display the chapter or track number you want. Playback starts from the selected chapter or track.

CLOSED CAPTION SKIP >>> To locate succeeding chapters or tracks.

CH RTN SKIP <<< Playback starts from the beginning of the current chapter or track. When you press twice in quick successions, playback starts from the beginning of the preceding chapter or track.

Note: Press and hold **SKIP** on the unit during playback to play forward or in reverse. Afterwards, each time you press and hold **SKIP**, the playback speed will change.

Notes:

- A prohibition symbol "🚫" may appear at the upper left of the screen. This symbol means either the feature you tried is not available on the disc, or the unit cannot access the feature at this time. This does not indicate a problem with the unit.
- The unit is capable of holding a still video image or On screen display image on your television screen indefinitely. If you leave the still video image or On screen display image displayed on your TV for an extended period of time, you risk permanent damage to your television screen. Projection televisions are very susceptible.

Basic playback (DVD)

Zooming/Locating desired scene

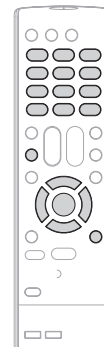

DISPLAY
0-9
JUMP
ENTER
▲/▼/◀/▶
CANCEL
ZOOM

Zooming

This unit will allow you to zoom in on the frame image. You can then make selections by switching the position of the frame.

1 Press ZOOM during playback.



The center part of the image will be zoomed in. Each press of ZOOM will change the ZOOM Q1 (x 1.3), Q2 (x 1.5) and Q3 (x 2.0).

2 Press ▲/▼/◀/▶ to view a different part of the frame.



You may move the frame from the center position to UP, DOWN, LEFT or RIGHT direction.

3 In the zoom mode press ZOOM repeatedly to return to a 1:1 view (Q Off).



Notes:

- You can select the Pause, Slow or Search playback in the zoom mode.
- Some discs may not respond to zoom feature.

Locating desired scene

Use the title, chapter and time recorded on the DVD disc to locate the desired point to play back. In the case of VCD/CD disc, time and track are used to locate the desired point to play back.

To check the title, chapter and time, press DISPLAY.

1 Press JUMP during playback or stop mode.

Time	: ---:--	--:--/----
Title	: ---	-/6
Chapter	: ---	-/-
▲▼/Enter/0-9/Cancel/Jump		

2 Press ▲ or ▼ to select the "Time", "Title" or "Chapter".



Time	: ---:--	--:--/----
Title	: ---	-/6
Chapter	: ---	-/-
▲▼/Enter/0-9/Cancel/Jump		

3 Press Number buttons (0-9) to change the number.

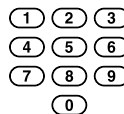

Time	: ---:--	--:--/----
Title	: ---	-/6
Chapter	: 12-	-/-
▲▼/Enter/0-9/Cancel/Jump		

- If you input a wrong number, press CANCEL.
- Refer to the package supplied with the disc to check the numbers.

4 Press ENTER. Playback starts.



- When you change the title, playback starts from Chapter 1 of the selected title.
- Some discs may not work in the above operation.

Note:

In case of the Video-CD playback with PBC, the JUMP does not work. To turn off PBC, see page 65.



Repeat playback/A-B Repeat playback

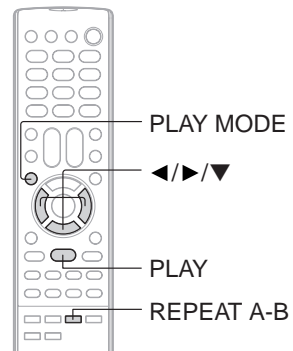

DVD VCD CD Repeat playback

1 Press PLAY MODE during playback or stop mode.

TRK-PLAY MODE

2 [DVD]
Press **◀/▶** to select "Chapter" or "Title".

The unit automatically starts repeat playback after finishing the current title or chapter.

Repeat : Off
▶/▶/Play Mode

[Audio CD, Video CD, MP3/WMA/JPEG CD]
Press **▼** to select "Repeat".
Press **◀/▶** to select "Track" or "All".

The unit automatically starts repeat playback after finishing the current track.

Play Mode : Off
Repeat : Off
▶▶/▶/Play Mode

- If you set the repeat mode during stop mode, press **PLAY** to start Repeat playback.

3 Press PLAY MODE again to make the screen disappear.

DVD VCD CD A-B Repeat playback

A-B repeat playback allows you to repeat material between two selected points.

1 Press REPEAT A-B during playback.

The start point is selected.

2 Press REPEAT A-B again.

The end point is selected. Playback starts at the point that you selected. Playback stops at the end point, returns to Point A automatically, then starts again.

To resume normal playback
Press **REPEAT A-B** again.

"Off" appears on the screen.

- Notes:**
- In A-B Repeat mode, subtitles near the A or B locations may not be displayed.
 - You cannot set the A-B Repeat for the scenes that include multiple angles.
 - A-B Repeat playback does not work when Repeat playback is activated.
 - You may not be able to set A-B Repeat, during certain scenes of the DVD.
 - A-B Repeat does not work with an interactive DVD.
 - A-B Repeat is prohibited when PBC is on.

- To resume normal playback**
Select Repeat : "Off" in step 2.
- Notes:**
- Some discs may not work with the repeat operation.
 - In case of Video CD with PBC, repeat functions are prohibited during playback.

Advanced playback (DVD)



Program playback/Random playback

You can arrange the playback order of tracks or files on the disc. And also the unit selects tracks or files at random and playback them. These feature works for Audio CD and Video CD.

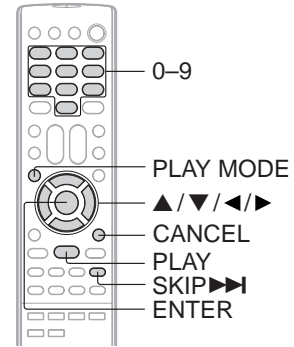

VCD CD Program playback

1 Press **PLAY MODE** in the stop mode.



Play Mode : Off
Repeat : Off
◀▶▶/Play Mode

2 Press **▲/▼** to select Play Mode, then press **◀/▶** to select "Program".



Play Mode : Program
Repeat : Off
1 --- 4 --- 7 --- 10 ---
2 --- 5 --- 8 --- 11 ---
3 --- 6 --- 9 --- 12 ---
[Clear] [Program Playback]
◀▶▶/Enter/0-9/Cancel/Play Mode

3 Press **▲/▼** or **◀/▶** to select the programming position. Use Number buttons (0-9) to input the Track or file numbers.



- To program others, repeat step 3.
- If you input a wrong number, press **CANCEL**.

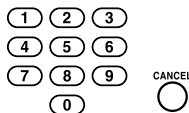

Play Mode : Program
Repeat : Off
1 9-- 4 --- 7 --- 10 ---
2 3-- 5 --- 8 --- 11 ---
3 11- 6 --- 9 --- 12 ---
[Clear] [Program Playback]
◀▶▶/Enter/0-9/Cancel/Play Mode

4 Press **▲/▼/◀/▶** to select "Program Playback" and press **ENTER**.

The programs you selected will start to playback in the order.

- In case of JPEG file, press **SKIP ▶▶** to continue the program playback.
- To resume normal playback, select Play Mode: "Off" in step 2.



Play Mode : Program
Repeat : Off
1 9-- 4 --- 7 --- 10 ---
2 3-- 5 --- 8 --- 11 ---
3 11- 6 --- 9 --- 12 ---
[Clear] [Program Playback]
◀▶▶/Enter/0-9/Cancel/Play Mode

■ To change the program

1. In the program mode, press **▲/▼/◀/▶** to select the track number.
2. Press **Number buttons (0-9)** to select the track number to be replaced.

■ To clear the program one by one

In the program mode, press **▲/▼/◀/▶** to select the track number. Then press **CANCEL**.

■ To clear all the programs

In the program mode, press **▲/▼/◀/▶** to select "Clear". Then press **ENTER**.

Notes:

- In playing back the Video CD with PBC, you cannot set Program playback.
- The program is cancelled when you open the disc tray or turn the power off.

VCD CD Random playback

1 Press **PLAY MODE** during playback or stop mode.



2 Press **▲/▼** to select Play Mode, then press **◀/▶** to select "Random".



Play Mode : Random
Repeat : Off
◀▶▶/Play Mode

3 Press **PLAY**.



The Random Playback will start.

- If you set "Random" during playback mode, Random playback will begin after the track that is currently being played has ended.
- To resume normal playback, select Play Mode: "Off" in step 2.

Note:

In playing back the Video CD with PBC, you can not set Random playback.



- ENTER
- DVD MENU
- ▲/▼/◀/▶
- PLAY
- ANGLE
- TOP MENU

DVD Changing angles

When playing back a disc recorded with multi-angle facility, you can change the angle that you are viewing the scene from.

- 1** Press ANGLE during playback.
The current angle will appear
- 2** Press ANGLE repeatedly until the desired angle is selected.

Change the DVD.

select the desired title.

PLAY.

Advanced playback (DVD)

language, etc. using the menu.

The menu continues to another screen. Repeat steps 2 and 3 to set the item completely.

m.

Changing soundtrack language/ Subtitles

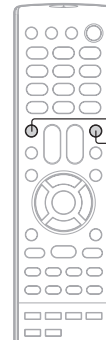

SUBTITLE
AUDIO SELECT

Changing soundtrack language

You can select the language when you play a multilingual disc.

1 Press AUDIO SELECT during playback.

 The current soundtrack language will appear.

 2/8 Fra Dolby Digital

2 Press AUDIO SELECT repeatedly until the desired language is selected.

 1/8 Eng Dolby Digital

- The on screen display will disappear after a few seconds.

■ In case of Video CD playback

Audio type changes as follows each time you press **AUDIO SELECT**.



Notes:

- If the desired language is not heard after pressing the button several times, the language is not recorded on the disc.
- Changing soundtrack language is cancelled when you open the disc tray. The initial default language or available language will be heard if the disc is played back again.
- If you select DTS in playing DTS-encoded disc, no sound will be heard from the unit's speakers.

Subtitles

When playing back a disc recorded with subtitles, you can select the subtitle language or turn the subtitle off.

1 Press SUBTITLE repeatedly during playback until your desired language appears.

2 To turn off the subtitle, press SUBTITLE until "Off" appears.

 Off

- The on screen display will disappear after a few seconds.

Notes:

- Depending on the DVD, you may not be able to change subtitles, or to turn subtitles on or off.
- While playing a DVD, the subtitle may change when you open or close the disc tray.
- In some cases, a selected subtitle language may not be changed immediately.

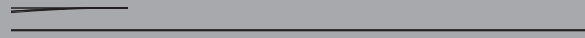
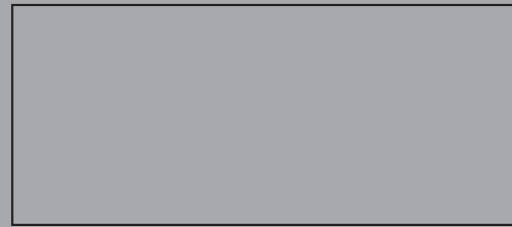

MP3/WMA/JPEG operation

This player can play back the MP3/WMA/JPEG-data which has been recorded on CD-R, CD-RW or Media card.

MP3/WMA/JPEG file information

Limitations on MP3/WMA/JPEG file playback

- MP3/WMA/JPEG file is the disc/card that is standardized by ISO9660, its file name must include 3-digits extension letters, "mp3", "wma", "jpg".
- MP3/WMA/JPEG file must be correspond to the ISO standardized files.
- This unit can read 600 files per disc/card. If one directory has more than 600 files, it reads up to 600 files, the remaining files will be omitted.
- The unit is able to recognize up to a maximum of 50 directories per disc/card.
- MP3/WMA/JPEG files cannot be used for the purpose of recording.
- If the disc/card has both audio tracks and MP3/WMA/JPEG files, only audio tracks are played.
- It may take more than one minute for this unit to read MP3/WMA/JPEG files depending on its structure.
- Music recorded by "Joliet Recording Specification" can be played back, the file name is displayed (within 16 letters) on the screen. Long file names will be condensed.
- The music files recorded by "Hierarchical File System" (HFS) cannot be played.

Limitations on display

- The maximum number for display is 16 letters.
Available letters for display are the following:
capital or small alphabets of A through Z, numbers of 0 through 9, and _ (under score).
- Other letters than those above are replaced in hyphen.

Notes on MP3/WMA/JPEG files

To play back MP3/WMA/JPEG file in the recorded order,

1. Use MP3/WMA/JPEG software that records data alphabetically or numerically.
2. Name each file including two-digit or three-digit number (ex. "01" "02" or "001" "002").
3. Refrain from making too many sub-folders.

CAUTION:

- Some MP3/WMA/JPEG CDs/Cards cannot be played back depending on the recording conditions.
- The CD/cards that has no music data or non MP3/WMA/JPEG files cannot be played back.

Standard, sampling frequency, and the bit rate:

MP3 file

MPEG-1 Audio

32kHz, 44.1kHz, 48kHz

32kbps ~ 320kbps (constant bit rate or variable bit rate)

The recommend recording setting for a high-quality sound is 44.1kHz of sampling frequency and 128kbps of constant bit rate.

WMA file

WMA version 7, and 8

32kHz, 48kbps

44.1kHz, 48kbps ~ 192kbps

48kHz, 128kbps ~ 192kbps

The file recorded by mono, 48kHz, 48 kbps is not available to this unit.

Microsoft, Windows Media, and Windows Logo are either registered trademarks or trademarks of Microsoft Corporation in the United States and/or other countries.



0-9

ENTER

▲/▼/◀/▶

STOP
PLAY

TOP MENU

MP3/WMA playback

- 1** Place a CD-R/RW on which MP3 or WMA files have been recorded onto the disc tray, or insert a Media card on which MP3 or WMA files have been recorded into the media card slot on the front panel.

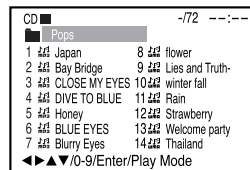

- 3** Press ▲/▼/◀/▶ or Number buttons (0-9) to select the desired file.

- In case the folder includes more than 15 files, press ◀ or ▶ to display next file list.

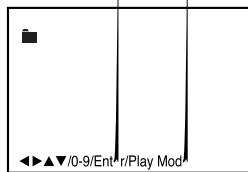

- When **PLAY** has been pressed after displaying the file menu, or when the disc tray has been closed using **PLAY**, playback begins automatically starting from the first file. In this case, if the first file is an MP3/WMA file, only MP3/WMA files are played back in order. If the first file is a JPEG file, the first JPEG file is played back.

- 4** Press **ENTER**.
The selected file starts playing back.

- 5** Press **STOP** to end playback.

About file menu

MP3/WMA/JPEG operation (continued)

CAUTION

Do not insert any foreign objects into the Media card slot as this can result in a risk of fire or electric shock.

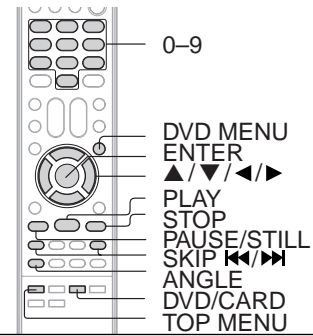

CD CARD JPEG playback

1 Place a CD-R/RW on which JPEG files have been recorded onto the disc tray, or insert a Media card on which JPEG files have been recorded into the media card slot on the front panel.

Note: When the media card is inserted, the unit is changed to the CARD mode automatically.

2 Press DVD/CARD to select the DVD (CD) mode or the CARD mode. A file menu screen will appear on the screen. Press ◀/▶ to select folder.



3 Press ▲/▼/◀/▶ or Number buttons (0-9) to select the desired file.

To display a picture menu, press DVD MENU. (To return to a file menu, press TOP MENU.) Press ◀/▶ or ▲/▼ to select the desired file.

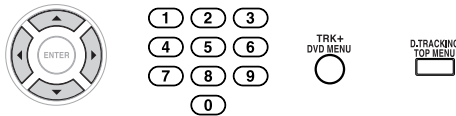

- To display next list, press SKIP ◀◀/▶▶.
- When PLAY has been pressed after displaying the file menu, or when the disc tray has been closed after pressing PLAY, playback begins automatically starting from the first file. In this case, if the first file is a JPEG file, the first JPEG file is played back. If the first file is an MP3/WMA file, only MP3/WMA files are played back in order.

4 Press ENTER. The selected picture appears on the screen.



Rotating an image

You can rotate an image by 90 degrees by pressing ANGLE during playback of the image. "◀▶", "▶◀", "◀▶▶" or "▶◀◀" appears briefly on the screen.

5 Press STOP to end playback.

The file menu appears on the screen. If you want to watch the other file, repeat steps 3 ~ 4.



CD CARD JPEG slide show

The slide show enables you to view pictures (files) one after another automatically.

Preparation:

Set "JPEG Interval" setting to "5 Seconds", "10 Seconds" or "15 Seconds" [72].

1 Select your desired starting file for the slide show in the step 4 as left.

2 Press ENTER to start slide show from the selected file.



- If you press PAUSE/STILL during the slide show, the slide show stops temporary. "||" appears briefly on the picture. If the picture appears upside down or sideways, press ANGLE repeatedly until it's right side up. "◀▶", "▶◀", "◀▶▶" or "▶◀◀" appears briefly on the screen. Press PLAY or SKIP ▶▶ again to resume the slide show.
- When the slide show playback finished the file list appears.
- To stop the slide show, press STOP. The file list appears.

To eject the Media card

Confirm the Media card is not in use now. Pull the card out slowly and straight.

Note:

Do not remove the card while it is in use. If removed while in use, information on the card may be lost.

This unit requires discs/recordings to meet certain technical standards in order to achieve optimal playback quality. Prerecorded DVDs are automatically set to these standards. There are many different types of recordable disc formats (including CD-R containing MP3/WMA files). Given the fact that technology in this area is still maturing, Toshiba cannot guarantee that all types of recordable discs will produce optimal playback quality. The technical criteria set out in this Owner's manual are meant as a guide only.

Please be advised that you must obtain permission from the applicable copyright owners to download copyrighted content, including music files, in any format, including the MP3 and WMA formats, prior to the downloading thereof. TOSHIBA has no right to grant and does not grant permission to download any copyrighted content.

Customizing the function settings

You can change the default settings to customize performance to your preference.

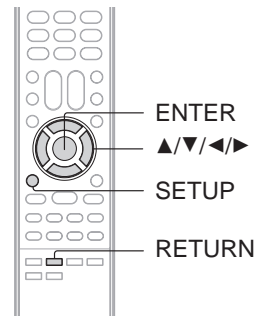

Setting procedure

1 Press SETUP during stop mode.



The following on-screen display appears.

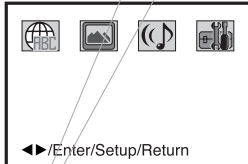

5 To make SETUP screen disappear, press SETUP or RETURN.



2 Press ◀ or ▶ to select the desired section, then press ▼ or ENTER.



3 Press ▲ or ▼ to select the desired option.







4 Change the selection using ◀ or ▶, by referring to the corresponding pages 71~73.

- Repeat steps 3 and 4 to change other settings.
- To select another operation, go back to step 2 by pressing ▲ repeatedly.

Customizing the function settings (continued)

Setting details

Section	Option	Details	Page
	Menu Subtitle Audio	To select the language of "Menu", "Subtitle" and "Audio" if more than one language are available on the disc.	71
	TV Screen	To select a picture size according to the aspect ratio of your TV.	
	Display	To turn on or de-activate the operational status display on the screen.	72
	Picture Mode	To select a preferred picture mode from "Auto", "Film" or "Video".	
	JPEG Interval	To select a preferred setting for the slide show playback.	
	DRC	To select On or Off for DRC (Dynamic Range Control).	73
	Password	Input 4-digit password to set the parental level.	
	Parental	To select a preferred parental level for the parental setting.	
	Select Files	To select a preferred file type for playing back a CD containing a mixture of file types.	

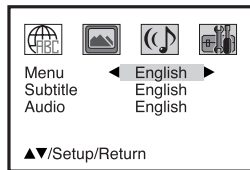

■ Menu, Subtitle, Audio

You can select the language of “Menu”, “Subtitle” and “Audio” if more than one languages are recorded onto the disc.

English, Francais, Espanol:

The selected language will be heard or seen.

Other:

Other language can be selected (see the “Language code list” [\[75\]](#)).

Original: (Audio)

The unit will select the first-priority language of each disc.

Off: (Subtitle)

Subtitles do not appear.

Notes:

- If the selected language is not recorded on the disc, the first-priority language is selected.
- If you want to change the OSD language, you can perform it by TV MENU [\[24\]](#).

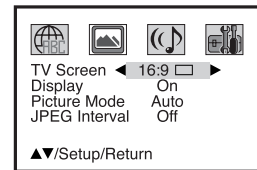

■ TV Screen

You have the following screen sizes to choose from:

16:9 Wide:

Select this mode when connecting to a wide-screen TV. A wide screen picture is displayed full size.

4:3 Letter box:

Select this mode when connecting to a conventional TV. When playing back a wide screen-DVD disc, it displays the wide picture with black bands at the top and bottom of screen.

4:3 Pan scan:

It displays the wide picture on the whole screen with left and right edges automatically cut off.

Press **OPEN/CLOSE** to view in the selected screen size.

Note:

If the DVD disc is not formatted in the pan & scan style, it displays 4:3 style.

■ Display

On screen display can be switched on or off when you press the buttons.

On: On screen displays appear when you press the buttons (factory setting).

Off: On screen displays do not appear when you press any buttons.

Customizing the function settings (continued)

Picture Mode

There are two types of source content in pictures recorded in DVD video discs: film content (pictures recorded from films at 24 frames per second) and video content (video signals recorded at 30 frames per second). Make this selection according to the type of content being viewed.

Auto: Select this position normally.
The DVD player automatically detects source content, film or video, of playback source.

Film: Suitable for playback of film content pictures.

Videocontent

Suitable for playbackt (ve of conten.

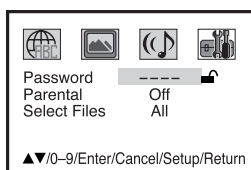
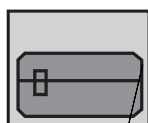

■ Parental control setting

Some discs are specified not suitable for children. Such discs can be limited not to play back with the unit.

- 1) Press ▲ or ▼ to select "Parental", then press ◀ or ▶ until the level you require appears.
 - Level Off: The parental control setting does not function.
 - Level 8: All DVD software can be played back.
 - Level 1: DVD software for adults cannot be played back.

Select from the level 1 to level 8. The limitation will be more severe as the level number is lower.

- 2) Press ▲ or ▼ to select "Password". Press **Number buttons (0-9)** to input a 4-digit password. Be sure to remember this number!
 - If you input a wrong number, press **CANCEL**.
- 3) Press **ENTER** to store the password.

Note: Now the rating is locked and the setting can not be changed unless you enter the correct password.
- 4) Press **OPEN/CLOSE** to activate Parental control setting. (See "Temporary disabling of rating level by DVD disc" [74](#))

Notes:

- Depending on the discs, the unit cannot limit playback.
- Some discs may not be encoded with specific rating level information though its disc jacket says "adult." For those discs, the age restriction will not work.

Temporary disabling of rating level by DVD disc

Depending on the DVD disc, the disc may try to temporarily cancel the rating level that you have set. It is up to you to decide whether to cancel the rating level or not.

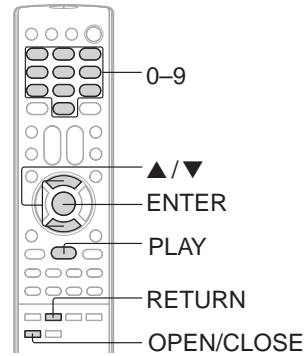

- 1** Load a DVD disc and press **PLAY** or **OPEN/CLOSE**.

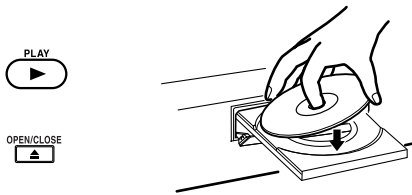

- 2** If the DVD disc has been designed to temporarily cancel the Rating level, the screen which follows the "Reading Disc" screen will change, depending on which disc is played. If you select "YES" with the **ENTER** key, "Your disc exceeds the parental control level#" screen will then appear.

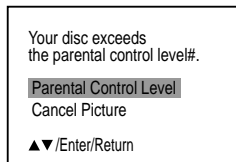

- 3** If you wish to cancel the set rating level temporarily, select "Parental Control Level" with **▲** or **▼**, then press **ENTER**. If the 4-digit password at step 2 on page 73 has been set, the password entering screen will appear as shown in step 4. Alternatively, if the password has not been set, playback will commence. If you don't know (or have forgotten) the password, select "Cancel Picture". The setting screen will disappear. Press **OPEN/CLOSE** to remove the disc.



- 4** Enter the password with Number buttons (0-9). Then press **ENTER**.

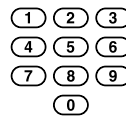

To exit from the entry, press **RETURN**.

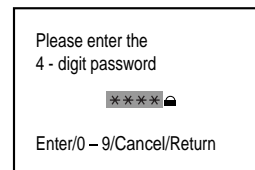
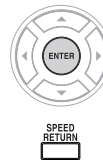

- 5** Playback will commence if the entered password was correct.

Note:

This temporary cancellation of rating level will be kept until the disc is ejected. When the disc is ejected, the original rating level will be set again automatically.

Language code list

Enter the appropriate code number for the initial settings "Menu", "Subtitle" and/or "Audio" **[71]**.

Language Name	Code	Language Name	Code	Language Name	Code	Language Name	Code
Abkhazian	1112	Fiji	1620	Lingala	2224	Singhalese	2919
Afar	1111	Finnish	1619	Lithuanian	2230	Slovak	2921
Afrikaans	1116	French	1628	Macedonian	2321	Slovenian	2922
Albanian	2927	Frisian	1635	Malagasy	2317	Somali	2925
Amharic	1123	Galician	1722	Malay	2329	Spanish	1529
Arabic	1128	Georgian	2111	Malayalam	2322	Sundanese	2931
Armenian	1835	German	1415	Maltese	2330	Swahili	2933
Assamese	1129	Greek	1522	Maori	2319	Swedish	2932
Aymara	1135	Greenlandic	2122	Marathi	2328	Tagalog	3022
Azerbaijani	1136	Guarani	1724	Moldavian	2325	Tajik	3017
Bashkir	1211	Gujarati	1731	Mongolian	2324	Tamil	3011
Basque	1531	Hausa	1811	Nauru	2411	Tatar	3030
Bengali; Bangla	1224	Hebrew	1933	Nepali	2415	Telugu	3015
Bhutani	1436	Hindi	1819	Norwegian	2425	Thai	3018
Bihari	1218	Hungarian	1831	Oriya	2528	Tibetan	1225
Breton	1228	Icelandic	1929	Panjabi	2611	Tigrinya	3019
Bulgarian	1217	Indonesian	1924	Pashto, Pushto	2629	Tonga	3025
Burmese	2335	Interlingua	1911	Persian	1611	Turkish	3028
Byelorussian	1215	Irish	1711	Polish	2622	Turkmen	3021
Cambodian	2123	Italian	1930	Portuguese	2630	Twi	3033
Catalan	1311	Japanese	2011	Quechua	2731	Ukrainian	3121
Chinese	3618	Javanese	2033	Rhaeto-Romance	2823	Urdu	3128
Corsican	1325	Kannada	2124	Romanian	2825	Uzbek	3136
Croatian	1828	Kashmiri	2129	Russian	2831	Vietnamese	3219
Czech	1329	Kazakh	2121	Samoan	2923	Volapük	3225
Danish	1411	Kirghiz	2135	Sanskrit	2911	Welsh	1335
Dutch	2422	Korean	2125	Scots Gaelic	1714	Wolof	3325
English	1524	Kurdish	2131	Serbian	2928	Xhosa	3418
Esperanto	1525	Laothian	2225	Serbo-Croatian	2918	Yiddish	2019
Estonian	1530	Latin	2211	Shona	2924	Yoruba	3525
Faroese	1625	Latvian, Lettish	2232	Sindhi	2914	Zulu	3631

Reception disturbances

Most types of television interference can be remedied by adjusting the height and position of the VHF/UHF antenna. Outdoor antennas are recommended for best results. The most common types of television interference are shown below. If one of these symptoms appear when the unit is connected to a cable TV system, the disturbance may be caused by the local cable TV company broadcast.

IGNITION

Black spots or horizontal streaks may appear, the picture may flutter or drift. Usually caused by interference from automobile ignition systems, neon lamps or AC powered tools and appliances such as drills or hair dryers.



GHOSTS

Ghosts are caused by the television signal following two paths. One is the direct path and the other is reflected by tall buildings, hills or other large objects. Changing the direction or position of the antenna may improve the reception.



SNOW

If the unit is located far from the TV station, in a fringe reception area where the signal is weak, small dots may appear in the picture. If the signal is extremely weak, the installation of a larger external antenna may be necessary.



RADIO FREQUENCY INTERFERENCE (RFI)

Caused by two-way radios, this type of interference produces moving ripples or diagonal streaks in the picture. Some cases may cause a loss of contrast in the picture. Changing the direction and position of the antenna or installing an RFI filter may improve the picture.



PICTURE SIZE VARIATION

A slight picture size variation is normal when you adjust the CONTRAST or BRIGHTNESS settings.



CARE AND MAINTENANCE

To prevent fire or shock hazard, disconnect the unit from the power source before cleaning. The finish on the cabinet may be cleaned with mild soap and a soft, damp cloth and cared for as other furniture. Use caution when cleaning or wiping the plastic parts.

Troubleshooting

Check the following guide for the possible cause of a problem before contacting service.

SYMPTOMS	CAUSE	POSSIBLE SOLUTIONS	PAGE
POWER			
No power.	The AC power cord is not connected.	Connect the AC power cord to the AC outlet.	5
Although the power is on, the unit does not operate.	Cassette or disc is not inserted.	Insert a video cassette or disc.	46, 57
	The TIMER REC button is depressed.	Press the TIMER REC button.	53
TV BROADCAST RECEPTION			
Poor or no picture.	TV station experiencing problems.	Try another channel.	25
	Picture control is not adjusted.	Check picture control adjustments.	38
	Possible local interference.	Check for source of reception disturbance.	76
	Antenna (CABLE) connector is not connected or possible local interference.	Check CABLE connection or VHF/UHF antenna, reposition or rotate antenna.	14, 15
Poor or no color.	TV station experiencing problems.	Try another channel.	25
	Picture control is not adjusted.	Check picture control adjustments.	38
	Possible local interference.	Check for source of reception disturbance.	76
	Antenna (CABLE) connector is not connected or possible local interference.	Check CABLE connection or VHF/UHF antenna, reposition or rotate antenna.	14, 15
Picture wobbles or drifts.	TV station experiencing problems.	Try another channel.	25
	Antenna (CABLE) connector is not connected or possible local interference.	Check CABLE connection or VHF/UHF antenna, reposition or rotate antenna.	14, 15
	Cable TV channel is scrambled.	Try another channel.	25
No CATV reception.	CABLE connector is not connected.	Check all CABLE connections.	15
	TV/CABLE selection is set to the TV position.	Set the selection to the CABLE position.	28
	Cable TV service interrupted.	Contact your Cable TV company.	–
No reception above channel 13.	TV/CABLE selection is not set to the appropriate position.	Make sure selection is in the appropriate position.	28
	UHF antenna is not connected.	Check UHF antenna.	14
Poor or no sound.	TV station experiencing problems.	Try another channel.	25
	Antenna (CABLE) connector is not connected or possible local interference.	Check CABLE connection or VHF/UHF antenna, reposition or rotate antenna.	14, 15
	Possible local interference.	Check for source of reception disturbance.	76
	The MUTE button is depressed.	Check the MUTE button has not been pressed.	26
TV shuts off.	TV station stopped broadcasting.	Tune new channel.	25
	Sleep timer is set.	Set Sleep Timer to "0h00m".	26
Closed caption is not activated.	TV station experiencing problems or program tuned is not closed captions.	Try another channel.	25
	TV signal is weak.	Check CABLE connection of VHF/UHF antenna, reposition or rotate antenna.	14, 15
	The CLOSED CAPTION button is not depressed.	Press the CLOSED CAPTION button to turn on the closed caption.	27

Others

Troubleshooting (continued)

SYMPTOMS	CAUSE	POSSIBLE SOLUTIONS	PAGE
VCR			
TV recording does not work.	The video cassette's erase prevention tab is broken off.	Place a piece of adhesive tape over the hole.	46
Timer recording does not work.	The time is not set correctly.	Reset the present time.	21~23
	The recording start/end time is not set correctly.	Reset the start/end time.	53
	The TIMER REC button have not been pressed (the TIMER REC indicator is not lit).	Press the TIMER REC button (the TIMER REC indicator is lit).	53
Noise bars appear on the screen.	Tape is old or worn.	Replace the tape.	–
	Tracking adjustment is beyond range of automatic tracking circuit.	Adjust tracking manually using the TRK +/- buttons on the remote control.	48
	Video heads are dirty.	Clean the video heads.	50
DVD			
The playback picture has occasional distortion.	The disc is dirty.	Eject the disc and clean it.	8
	It is in fast forward or fast reverse playback.	Some times a small amount of picture distortion may appear. This is not a malfunction.	–
The unit does not start playback.	No disc is inserted.	Insert a disc.	57
	An unplayable disc is inserted.	Insert a playable disc (Check the disc type and color system).	9
	The disc is placed upside down.	Place the disc with the playback side down.	57
	The disc is not placed within the guide.	Place the disc correctly inside the guide on the disc tray.	57
	The disc is dirty.	Clean the disc.	8
	The parental lock function is set.	Cancel the parental lock function or change the parental lock level.	73, 74
Playback does not follow the course of the disc's program.	It is in the mode of repeat playback, memory playback, etc.	These operations may prevent a proper progress of the contents.	–
 appears on the screen.	The function is prohibited with the unit or the disc.	–	9
REMOTE CONTROL			
Remote control does not operate.	The remote control is not aimed at the sensor.	Aim the remote control at the remote sensor.	13
	Distance is too far or too much light in the room.	Operate within 5 m or reduce the light of the room.	13
	There is an obstacle in the path of the beam.	Clear the path of the beam.	13
	The batteries are weak.	Replace the batteries.	13
	The batteries are not inserted correctly.	Insert correctly.	13

Specifications

	MW26G71	MW30G71
General		
Power supply	AC 120 V 60 Hz	
Power consumption		
Operation:	188 W	195 W
Stand by:	4 W	
Picture tube	26 inches (656.7 mm) diagonal*	30 inches (760 mm) diagonal*
Speaker	2 x 3-1/2 inches (51x 89 mm), 8 Ω x 2	2 x 4-11/16 inches (51x 119 mm), 8 Ω x 2
Audio output power	2.5 W + 2.5 W	
Weight	89.3 lbs (40.5 kg)	117.9 lbs (53.5 kg)
Dimensions		
Width:	27-9/16 inches (700 mm)	31-5/16 inches (796 mm)
Height:	21-3/4 inches (553 mm)	23-3/4 inches (602.5 mm)
Depth:	19-13/16 inches (504 mm)	22-3/8 inches (568 mm)
Tuner	181 channel freq. synthesized VHF 2-13 UHF 14-69 CATV 4A, A-5~A-1, J~W, W+1~W+84	
Antenna input	UHF/VHF: 75 Ω coaxial	
Color system	NTSC	
Video head	4 Rotary heads	
Audio track	Hi-Fi sound - 2 Tracks / MONO sound - 1 Track	
Hi-Fi frequency response	20 Hz to 20,000 Hz	
Hi-Fi dynamic range	More than 90 dB	
F.FWD/REW time at 25°C (77°F)	Approx. 1 minute and 48 seconds (with T-120 cassette tape)	
Applicable disc	DVD (12 cm, 8 cm), CD (12 cm, 8 cm)	
Frequency range	DVD: 4 Hz-22 kHz, CD: 4 Hz-20 kHz	
Operating conditions	Temperature: 5°C-40°C (41°F-104°F), Operating status: Horizontal	
Input/Output		
Video input	1.0 V (p-p), 75 Ω, negative sync., pin jack x 2	
Audio input	-8 dBm, 50 kΩ, negative sync., pin jack (L/R) x 2	
S-Video input	Y: 1.0 V (p-p), 75 Ω, negative sync. C: 0.286 V (p-p) (burst signal), 75 Ω	
ColorStream® (component video) input	Y: 1.0 V (p-p), 75 Ω PR: 0.7 V (p-p), 75 Ω PB: 0.7 V (p-p), 75 Ω	
HDMI input	HDMI compliant (type A connector), HDCP compliant, E-EDID compliant	
HDMI Audio input	Suggested scan rates: 1080i, 480p, 480i, 720p 2-channel PCM, 32/44.1/48 kHz sampling frequency, 16/20/24 bits per sample	
Audio output	DIGITAL COAXIAL: 0.5 V (p-p), 75 Ω, pin jack x 1 OPTICAL DIGITAL : Optical connector x 1	
Supplied accessories		
Remote control (WC-SBG1)	1	
Batteries (AAA)	2	
300-75 Ω matching transformer	1	

* Screen size is approximate.

- This model complies with the above specifications.
- Designs and specifications are subject to change without notice.
- This model may not be compatible with features and/or specifications that may be added in the future.

Others

Limited United States Warranty

for models MW26G71 and MW30G71 ("TV Combination(s)")

Toshiba America Consumer Products, L.L.C. ("TACP") makes the following limited warranties to original consumers in the United States. **THESE LIMITED WARRANTIES EXTEND TO THE ORIGINAL CONSUMER PURCHASER OR ANY PERSON RECEIVING THIS TV COMBINATION AS A GIFT FROM THE ORIGINAL CONSUMER PURCHASER AND TO NO OTHER PURCHASER OR TRANSFEREE.**

TV COMBINATIONS PURCHASED IN THE U.S.A. AND USED ANYWHERE OUTSIDE OF THE U.S.A., INCLUDING, WITHOUT LIMITATION, CANADA AND MEXICO, ARE NOT COVERED BY THESE WARRANTIES. TV COMBINATIONS PURCHASED ANYWHERE OUTSIDE OF THE U.S.A., INCLUDING, WITHOUT LIMITATION, CANADA AND MEXICO, AND USED IN THE U.S.A., ARE NOT COVERED BY THESE WARRANTIES.

Limited Ninety (90) Day Warranty on Labor

TACP warrants this TV Combination and its parts against defects in materials or workmanship for a period of ninety (90) days after the date of original retail purchase. **DURING THIS PERIOD, TACP WILL, AT TACP'S OPTION, REPAIR OR REPLACE A DEFECTIVE PART WITH A NEW OR REFURBISHED PART WITHOUT CHARGE TO YOU FOR PARTS OR LABOR.** During this period, TACP Authorized Service Station personnel will come to your home when warranty service is required. Depending on the type of repair required, the service will either be performed in your home or the TV Combination will be taken to a TACP Authorized Service Station for repair and returned to your home at no cost to you.

Limited One (1) Year Warranty on Parts

TACP further warrants the parts in this TV Combination against defects in materials or workmanship for a period of one (1) year after the date of original retail purchase. **DURING THIS PERIOD, TACP WILL, AT TACP'S OPTION, REPAIR OR REPLACE A DEFECTIVE PART WITH A NEW OR REFURBISHED PART WITHOUT CHARGE TO YOU FOR THE PART, PROVIDED THAT IF A DEFECTIVE PART IS REPAIRED OR REPLACED AFTER NINETY (90) DAYS AFTER THE DATE OF ORIGINAL RETAIL PURCHASE, YOU MUST PAY ALL LABOR CHARGES IN CONNECTION WITH THE REPAIR OR REPLACEMENT THEREOF.** After the date that is ninety (90) days after the date of original retail purchase, you may request in-home service at your expense, or you may deliver the entire TV Combination to a TACP Authorized Service Station. If you elect to deliver the entire TV Combination to a TACP Authorized Service Station, you must pay for all transportation and insurance charges for the TV Combination to and from the TACP Authorized Service Station.

Limited Two (2) Year Warranty on Picture Tube

TACP further warrants the picture tube in this TV Combination against defects in materials or workmanship for a period of two (2) years after the date of original retail purchase. **DURING THIS PERIOD, TACP WILL, AT TACP'S OPTION, REPAIR OR REPLACE A DEFECTIVE PICTURE TUBE WITH A NEW OR REFURBISHED PICTURE TUBE WITHOUT CHARGE TO YOU, PROVIDED THAT IF A DEFECTIVE PICTURE TUBE IS REPAIRED OR REPLACED AFTER NINETY (90) DAYS AFTER THE DATE OF ORIGINAL RETAIL PURCHASE, YOU MUST PAY FOR ALL LABOR CHARGES IN CONNECTION WITH THE REPAIR OR REPLACEMENT THEREOF.** After the date that is ninety (90) days after the date of original retail purchase, you may request in-home service at your expense, or you may deliver the entire TV Combination to a TACP Authorized Service Station. If you elect to deliver the entire TV Combination to a TACP Authorized Service Station, you must pay for all transportation and insurance charges for the TV Combination to and from the TACP Authorized Service Station.

Rental Units

The warranty for TV Combination rental units begins on the date of the first rental or thirty (30) days after the date of shipment to the rental firm, whichever comes first.

Limited Warranty for Commercial Units

TACP warrants TV Combinations that are sold and used for commercial purposes as follows: all parts are warranted against defects in materials or workmanship for a period of ninety (90) after the date of original retail purchase. **DURING THIS PERIOD, TACP WILL, AT TACP'S OPTION, REPAIR OR REPLACE A DEFECTIVE PART WITH A NEW OR REFURBISHED PART WITHOUT CHARGE TO YOU.**

Owner's Manual and Product Registration Card

Read this owner's manual thoroughly before operating this TV Combination. Complete and mail the enclosed product registration card or register your TV Combination online at www.tacp.toshiba.com/service as soon as possible. By registering your TV Combination you will enable TACP to bring you new products specifically designed to meet your needs and help us to contact you in the unlikely event a safety notification is required under the U.S. Consumer Product Safety Act. Failure to complete and return the product registration card does not diminish your warranty rights.



Your Responsibility

THE ABOVE WARRANTIES ARE SUBJECT TO THE FOLLOWING CONDITIONS:

- (1) You must retain your original bill of sale or provide other proof of purchase.
- (2) All warranty servicing of this TV Combination must be performed by an Authorized TACP Service Station.
- (3) The warranties from TACP are effective only if this TV Combination is purchased and operated in the Continental U.S.A. or Puerto Rico.
- (4) Labor service charges for set installation, setup, adjustment of customer controls, and installation or repair of antenna systems are not covered by this warranty. Reception problems caused by inadequate antenna systems, misaligned satellite dishes, cable television distribution, VCRs, DVD players/recorders, personal computer level IEEE-1394 devices, and any other connected signal source device are your responsibility.
- (5) Warranties extend only to defects in materials or workmanship as limited above, and do not extend to any TV Combination or parts that have been lost or discarded by you or to damage to the TV Combination or parts caused by fires, misuse, accident, Acts of God (such as lightning or fluctuations in electric power), improper installation, improper maintenance, or use in violation of instructions furnished by TACP; use or malfunction through simultaneous use of this TV Combination and connected equipment; or to units that have been modified or had the serial number removed, altered, defaced, or rendered illegible.

How to Obtain Warranty Service

If, after following all of the operating instructions in this manual and reviewing the section entitled "Troubleshooting," you find that service is needed:

- (1) To find the nearest TACP Authorized Service Station, visit TACP's website at www.tacp.toshiba.com/service or contact TACP's Consumer Solution Center toll free at 1-800-631-3811.
- (2) You must present your original bill of sale or other proof of purchase to the TACP Authorized Service Station.

For additional information, visit TACP's website:
www.tacp.toshiba.com

ALL WARRANTIES IMPLIED BY THE LAW OF ANY STATE OF THE U.S.A., INCLUDING THE IMPLIED WARRANTIES OF MERCHANTABILITY AND FITNESS FOR A PARTICULAR PURPOSE, ARE EXPRESSLY LIMITED TO THE DURATION OF THE LIMITED WARRANTIES SET FORTH ABOVE. WITH THE EXCEPTION OF ANY WARRANTIES IMPLIED BY THE LAW OF ANY STATE OF THE U.S.A. AS HEREBY LIMITED, THE FOREGOING WARRANTY IS EXCLUSIVE AND IN LIEU OF ALL OTHER WARRANTIES, GUARANTEES, AGREEMENTS, AND SIMILAR OBLIGATIONS OF TACP WITH RESPECT TO THE REPAIR OR REPLACEMENT OF ANY PARTS. IN NO EVENT SHALL TACP BE LIABLE FOR CONSEQUENTIAL OR INCIDENTAL DAMAGES (INCLUDING, BUT NOT LIMITED TO, LOST PROFITS, BUSINESS INTERRUPTION, OR MODIFICATION OR ERASURE OF RECORDED DATA CAUSED BY USE, MISUSE OR INABILITY TO USE THIS TV COMBINATION).

No person, agent, distributor, dealer, or company is authorized to change, modify, or extend the terms of these warranties in any manner whatsoever. The time within which an action must be commenced to enforce any obligation of TACP arising under the warranty or under any statute or law of the United States or any state thereof is hereby limited to ninety (90) days from the date you discover, or should have discovered, the defect. This limitation does not apply to implied warranties arising under the law of any state of the U.S.A.

Others

THIS WARRANTY GIVES YOU SPECIFIC LEGAL RIGHTS AND YOU MAY ALSO HAVE OTHER RIGHTS WHICH MAY VARY FROM STATE TO STATE IN THE U.S.A. SOME STATES OF THE U.S.A. DO NOT ALLOW LIMITATIONS ON THE DURATION OF AN IMPLIED WARRANTY, WHEN AN ACTION MAY BE BROUGHT, OR THE EXCLUSION OR LIMITATION OF INCIDENTAL OR CONSEQUENTIAL DAMAGES. THEREFORE, THE ABOVE PROVISIONS MAY NOT APPLY TO YOU UNDER SUCH CIRCUMSTANCES.





A series of 20 horizontal dotted lines spanning the width of the page, intended for handwritten text or notes.





TOSHIBA

TOSHIBA AMERICA CONSUMER PRODUCTS, L.L.C.

CableClear, ColorStream and TheaterWide are registered trademarks of Toshiba America Consumer Products, L.L.C.

GameTimer is a trademark of Toshiba America Consumer Products, L.L.C.



J5U30101B SH 05/04

Printed in Thailand